

botek[®]

DEEP HOLE DRILLING SYSTEMS
SOLID CARBIDE TOOLS

Single flute gundrills

Type 110, 111, 112
113, 113-HP, 114, 115



botek

**NEW: Stock Program and
Express Production Line for
Single flute gundrills
Type 110/Type 113/Type 113-HP**

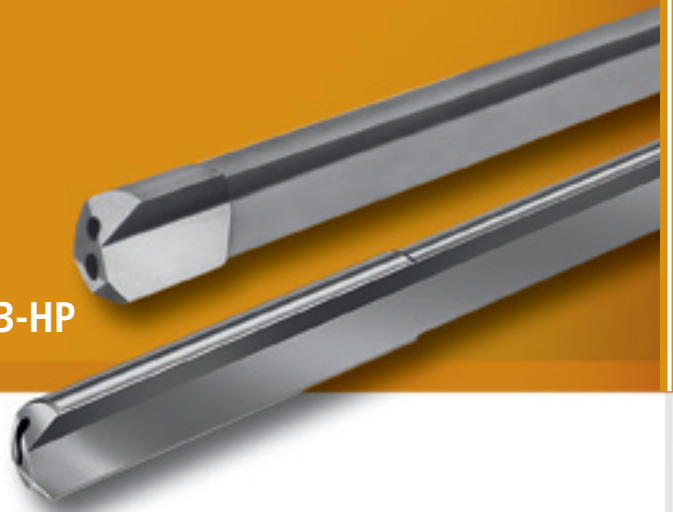

**Solid drilling tools
Counterboring tools
Trepanning tools**



The botek company

Manufacturing deep and precise holes is a technical challenge when processing metal. Accordingly specializing on deep hole drilling technology had been the founding idea in 1974 of botek Präzisionsbohrtechnik GmbH in Riederich.

botek grew to an international operating deep hole drilling tools supplier. Over 500 employees in the main company develop and manufacture single and two fluted drills, deep hole drilling tools system BTA and Ejector as well as special tools.

A complete product program, regarding all deep hole drilling aspects and a team of highly qualified and dedicated cutting specialists make botek being a competent partner for the automobile industry and their suppliers, shipbuilding industry, hydraulic industry as well as motor, gear and machine building companies.



- Please note our safety pointers at www.botek.de.
- Our General Standard Terms and Conditions, which we assume as known, apply.
- We reserve the right to make modifications in the interests of technical improvement. Such modifications cannot, in principle, be accepted as justifiable reasons for complaint.
- Subject to change. The manufacturer accepts no responsibility for misprints and other errors.



Contents

- p. 2 The botek company
- p. 2 Terms and conditions, important informations
- p. 3 Contents

Tools

- p. 4 botek advantages
- p. 5 The gundrilling process and the requirements for application
- Information on the guide hole (pilot hole) and guide values

Solid carbide single flute gundrill

Type 113/Type 113-HP

- p. 6 Overview
- p. 6 Tool design
- p. 6 Nose grind geometry
- p. 7 Application notes Type 113-HP
- p. 8 Solid drilling and counterboring tools
- p. 8 Drill shaft
- p. 9 Driver (overview and order numbers)
- p. 10 Stock Program Type 113
- p. 11 Stock Program Type 113-HP
- p. 12/13 Express Order Line Type 113

Single flute gundrill with brazed carbide head

Type 110/Type 111/Type 112/Type 114/Type 115

- p. 14 Overview
- p. 14 Tool design
- p. 15 Drill head (peripheral contour and nose grind geometry)
- p. 16 Solid drilling tools (Type 110, Type 111, Type 112, Type 01)
- p. 17 Counterboring/Trepanning tools (Type 114, Type 115)
- p. 18/19 Driver (overview and order numbers)
- p. 20/21 Stock Program Type 110
- p. 22 Express Order Line Type 110

Form

- p. 23 Inquiry/Order
Type 113, Type 113-HP, Type 110

Technical information

- p. 24 Drilling quality (achievable drilling tolerances, surface quality)
- p. 25 Drilling quality (centerline deviation, hole straightness, roundness)
- p. 26/27 Guide values Type 113
- p. 28/29 Guide values Type 113-HP
- p. 30/31 Guide values Type 110/Type 111
- p. 32/33 Application notes for botek deep hole drilling tools (single flute gundrills)

Accessories

- p. 34/35 Consumable accessories
- p. 36/37 Service
- p. 38 Regrinding
- p. 39 Coolant pressure gauging kit/Rotating coolant connector

botek advantages

1. Cost effective and precise holemaking.
2. botek quality tools are synonymous with high cutting performance.
3. Minimum centerline deviation.
4. Outstanding drilling quality and trouble-free chip removal.
5. High process reliability.
6. Tool lengths up to 5,000 mm are available depending on tool type and tool dia.
7. Diametric tolerances up to IT 7 are possible under specific conditions.
8. Suitable for use on machining centres and turning machines with high pressure coolant system.
9. Minimum quantity lubrication (MQL) is possible under certain conditions.
10. Drills can be used horizontally or vertically with either tool, workpiece or counterrotation.
11. Tools can be reground at botek's factory or in your facility (see brochure: botek grinding machines and accessories).
12. Gundrills are optimally adapted by botek to machining requirements in close cooperation with the customer.
13. Each of our tools is the product of over 40 years' experience in deep hole drill production and applications.
14. We develop and manufacture tools for all deep hole drilling processes (Gundrilling, BTA and Ejector).
15. The solid carbide single flute gundrill (Type 113) was developed and manufactured by botek since 1982. This innovative technology made it possible, for the first time, gundrilling down to diameters less than 2 mm. This capability is, among other things, a prerequisite for the production of modern fuel injection systems.
16. botek is the world market leader in the field of single flute gundrills.

The gundrilling process and the requirements for application

The characteristic of the single flute gundrilling process is that coolant is fed through the coolant hole in the tool and exits along with the chips in the V-shaped groove (flute) on the drill tube from the drilled hole. The coolant also provides lubrication to the drill periphery.

This is possible if coolant, i. e. deep-hole drilling oil or emulsion (min. 10 - 12 % concentration, with additives), is provided in sufficient quantity and pressure (coolant information see page 26 - 31).

Minimum quantity lubrication (MQL) may be used under certain conditions.

High pressure coolant systems should already be integrated in the machine or can be provided as a separate unit by the machine's manufacturer. Economical deep-hole drilling is therefore, not only possible on special deep-hole drilling machines but also on CNC machining centres (lathes, horizontal boring machines, etc.).

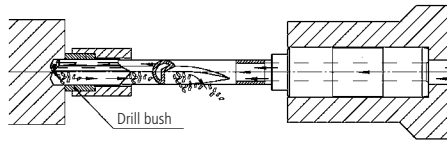

Information on the guide hole (pilot hole)

with drill bush

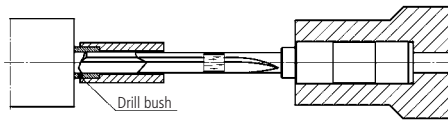

with pilot hole

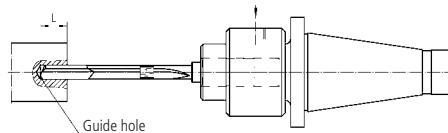

The gundrill is a single-edged tool without self-centering. When positioning the drill, the tool must be guided through a drill bush or a pilot hole.

The quality of the pilot hole affects the drilling performance (tool life, centerline deviation, etc.).

Dimensions for the pilot hole Type 113/113-HP

	Drill diameter	Pilot hole diameter	Pilot hole depth matched to the tool length (without driver)				
			LxD drilling depth	Pilot hole depth			
				Ø 0.500 - 1.599	Ø 1.600 - 3.999	Ø 4.000 - 6.999	Ø 7.000 - 12.000
	0.500 mm - 4.000 mm	+ 0.005 to + 0.010	ap. 20xD	3.0 x D	2.0 x D	2.0 x D	2.5 x D
	4.001 mm - 12.000 mm	+ 0.010 to + 0.020	ap. 30xD		3.0 x D	3.0 x D	3.5 x D
			ap. 40xD		4.0 x D	4.0 x D	40 mm
			ap. 50xD	6.0 x D	6.0 x D		
			ap. 60xD	6.0 x D	30 mm	35 mm	
			> 60xD				

Dimensions for the pilot hole Type 110

	Drill diameter	Pilot hole diameter	Pilot hole depth matched to the tool length (without driver)							
			LxD drilling depth	Pilot hole depth						
				Ø 1.850 - 4.000	Ø 4.001 - 8.500	Ø 8.501 - 12.000	Ø 12.001 - 20.999	Ø 21.000 - 30.999	Ø 31.000 - 40.999	Ø 41.000 - 55.000
	1.85 mm - 4.00 mm	+ 0.005 to + 0.010	ap. 10xD	2.0 x D	1.0 x D	1.0 x D	1.0 x D	1 x D	1 x D	1 x D
	4.01 mm - 12.00 mm	+ 0.010 to + 0.020	ap. 20xD	3.0 x D	1.5 x D	1.5 x D	1.5 x D			
	12.01 mm - 50.00 mm	+ 0.015 to + 0.040	ap. 25xD	4.0 x D	2.0 x D	2.0 x D	1.5 x D			
			ap. 30xD	6.0 x D	3.0 x D	3.0 x D	1.5 x D			
			ap. 35xD	30 mm	35 mm	3.0 x D	1.5 x D			
			ap. 40xD							





The dimensions specified in the table are guide values. To avoid chipping of the cutting edge, a chamfered pilot hole (F) is recommended depending on machining requirements.

→ Please read our application notes on page 32 + 33

Solid carbide gundrill

Type 113

Overview

Type	Tool dia.	
Type 113 Solid carbide gundrill	kidney-shaped coolant channel for tool dia.: 0.500 - 12.000 mm	
Type 113-HP Solid carbide gundrill	kidney-shaped coolant channel for tool dia.: 0.700 - 12.000 mm	
Type 113-01* Solid carbide stepped drill	kidney-shaped coolant channel for tool dia.: 1.500 - ... mm	
Type 113-02 Solid carbide counterboring tool	kidney-shaped coolant channel for tool dia.: 0.500 - 12.000 mm	

*Tool on request only

Tool design

Drill tip and drill tube are manufactured from a single piece of carbide blank. The advantage of this tool is high process reliability and performance. Longer tool life is possible because of reduced torsional vibrations and higher rigidity.

With this tool type, the driver (steel) has a "pin". The driver and the drill tube are connected by a brazed joint.

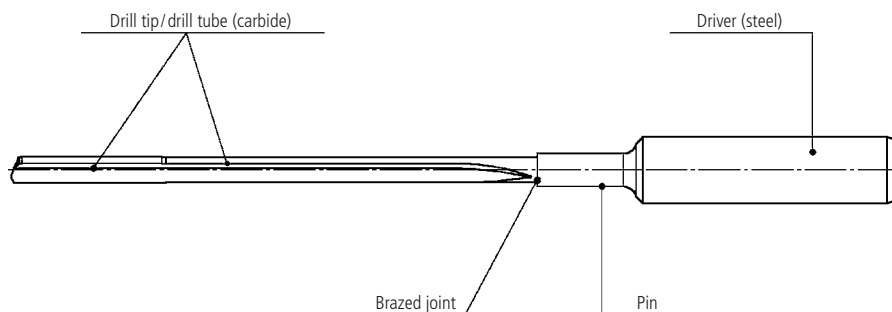

Nose grind geometry

The nose grind geometry affect the following, hole tolerance, chip formation, coolant pressure and flow, tool life, centerline deviation and surface quality. Over the years, botek has successfully tested a number of different nose grinds for drilling various materials.

botek's experience has formed the foundation for the development of our standard nose grind geometries. This meets the requirements of most drilling applications. Deep hole drilling of especially long chipping materials and difficult to machine materials usually call for special nose grind geometries, and in some cases, made to order chip breakers, all available from botek.

Standard nose grinds for Type 113

	
SA-0009 for drill range: 0.500 - 4.000 mm	SA-0002 for drill range: 4.001 - 12.000 mm

Solid carbide gundrill Type 113-HP

Drilling Examples

Type 113-HP (Patent pending)

Ø 0.700 - 12.000 mm

High performance tool design newly developed ALTERNATIVE SOLUTION to carbide twist drills







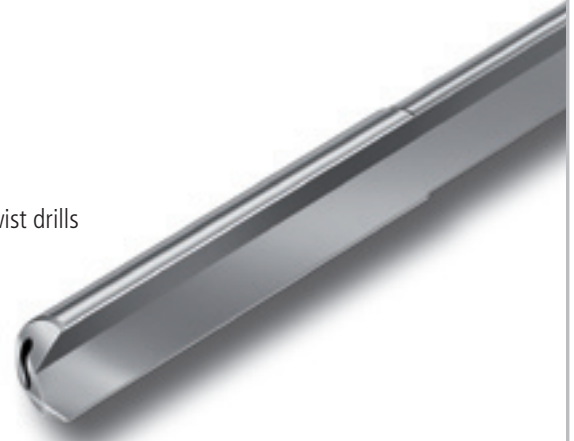

Advantages

- Maximum cutting performance
- Up to 800% higher feed rates
- Very efficient for drilling long chipping steels
- Fast and cost effective regrinding

Suitable for drilling with cutting oil, MQL and high quality emulsion.



Drilling Examples

				
Material	AlSi7Mg0,3 T73	42CrMo4	38MnSV4	50CrMo4
Diameter x drilling depth	7.0 x 210 mm	5.0 x 100 mm	5.0 x 100 mm	3.0 x 95 mm
Coolant/pressure	Emulsion/70 bar	MQL	Deep hole oil/110 bar	Deep hole oil/140 bar
Cutting speed	150 m/min	70 m/min	70 m/min	80 m/min
Feed f Vf	f = 0.25 mm/rev Vf = 1700 mm/min	f = 0.18 mm/rev Vf = 800 mm/min	f = 0.22 mm/rev Vf = 1000 mm/min	f = 0.11 mm/rev Vf = 950 mm/min
				
Material	X46Cr13	Forged + tempered steel	Aluminium wrought alloy	Forged + tempered steel
Diameter x drilling depth	5.0 x 120 mm	9.0 x 300 mm	2.5 x 60 mm	6.0 x 350 mm
Coolant	Oil	Oil	Oil	Oil
Cutting speed	90 m/min	70 m/min	110 m/min	70 m/min
Feed f Vf	f = 0.115 mm/rev Vf = 660 mm/min	f = 0.16 mm/rev Vf = 400 mm/min	f = 0.36 mm/rev Vf = 5000 mm/min	f = 0.11 mm/rev Vf = 400 mm/min

Comparison between carbide twist drill and solid carbide drill Type 113-HP







Work piece:	crank shaft, forged steel
Diameter:	5.0 mm
Drilling depth:	90 mm
MQL:	8 bar
Vc:	76 m/min. (4800 rev/min)
Vf:	800 mm/min (0.17 mm/rev)

Result	Solid carbide twist drill	Type 113-HP
Hole tolerance	IT9/IT10	IT8
Surface finish Ra	1.5 - 3.0	0.8
Centerline deviation (drift)	> 0.15	< 0.1

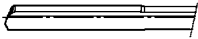
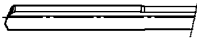
Solid carbide gundrill

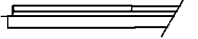
Type 113

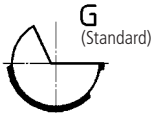
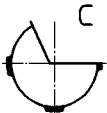
Solid drilling and counterboring tools

Design of drill head and shank	Solid carbide design			
Working method/ tool type	Solid drilling tools			Counterboring tools
	Type 113	Type 113-HP	Type 113-01	Type 113-02
Illustration				
Drilling range from - to (mm)	Ø = 0.500 - 12.000 mm	Ø = 0.700 - 12.000 mm	Ø = 1.500 - ... mm	Ø = 0.500 - 12.000 mm
Tool length	Available up to 100 x diameter			
Coolant hole design	 Kidney-shaped coolant channel			
Advantages	<ul style="list-style-type: none"> - Deep holes with extremely small diameters can be drilled - Solid carbide design, drill head and drill shaft in one piece, allows greater rigidity reducing vibration and tensional flex during drilling - Higher feedrates are possible/greater penetration feed rates - Various peripheral contours for greater application flexibility - Even higher cutting speeds are possible compared to the gundrill with brazed carbide tip (Type 110) - Regrindable - Optimum coolant flow due to kidney shaped coolant channel - Minimized drift by higher tool rigidity 			
Peripheral contours botek adapts the contour optimally to meet your drilling requirements!	 G (Standard)	 C		
	<ul style="list-style-type: none"> - All materials - Suitable for most drilling requirements - Close hole tolerance - Minimum drift 	<ul style="list-style-type: none"> - Steel, stainless steel - Not easily machinable materials - Preferred for water soluble (emulsion) coolant 		
Important: Contour EA and G are non-micable!	 EA	 A		
	<ul style="list-style-type: none"> - Cast iron, malleable materials - Crosshole drilling - Angular entrance and exit bores 	<ul style="list-style-type: none"> - Aluminium, Copper - close hole tolerance 		
Special contour	Also available upon special request			
Special nose grinds	All tools are also available with special nose grind			
Tool coatings	Please specify the coating you require			
Diamond/PCD	Also available with PCD cutting edge			

Drill shaft

The drill tube and tip are made entirely of solid carbide with a kidney shaped coolant channel. Coolant and chips are flushed out of the drilled hole via the V-shaped groove, or flute, on the drill shank.

With standard tool designs, the V-shaped flute extends to the driver (pin). Solid carbide gundrills are available with a drill shank-length up to 100 x diameter.

Solid carbide gundrill Type 113

Driver

botek solid carbide gundrills are made complete with drivers. Drivers transmit the torque from the machine to the drill. High rotational accuracy between the drill shank and the driver avoids additional vibration, thereby increasing the cutting performance and process reliability of the tools. In addition to a large number of standard drivers, botek manufactures drivers also to customer specifications.

Cylindrical drivers (DIN 6535 HA) used in hydraulic chucks or sealed collets achieve best true running, typical on machining centres.

Standard drivers with pin for solid carbide gundrills – Overview

Designation		Drawing	botek driver no.	for tool length calculation			X = Notch location	TD = Thread size
Ø dia. (mm)	Type			drill dia. (mm) from - to	LSC	LS Driver with pin		
6			ZH6-03	0.500 - 4.649	30	45	17	
10	ideal for hydraulic chucks and collets		ZH10-15	0.500 - 6.349	55	70		M6x0.5
10			ZH10-37	0.500 - 5.249	40	55	32.7	M6x0.5
10			ZH10-42	0.500 - 7.249	40	55	24	
12.7			ZH12.7-01	0.500 - 6.349	38	48	25.4	
12.7	ideal for hydraulic chucks and collets		ZH12.7-09	0.500 - 6.349	51	65		M6x0.5
16			ZH16-75	0.500 - 8.049	80	105	37	M10x1
4	DIN 6535-HA ideal for hydraulic chucks and collets		ZH4-08	0.500 - 5.149	34	46		
6			ZH6-12	0.500 - 4.649	36	50		
10			ZH10-51	0.500 - 7.249	40	55		
12			ZH12-27-1	0.500 - 8.049	45	60		
16			ZH16-86-1	0.500 - 8.049	48	63		
6	DIN 6535-HB		ZH6-13	0.500 - 4.649	36	50	20	
10			ZH10-47	0.500 - 7.249	40	55	23.5	
12			ZH12-30	0.500 - 8.049	45	60	26.5	
16	DIN 1835-B		ZH16-78-1	0.500 - 8.049	48	63	29	
6	DIN 6535-HE		ZH6-01	0.500 - 4.649	36	50	25	
10			ZH10-49	0.500 - 7.249	40	55	28	
12			ZH12-28	0.500 - 8.049	45	60	33	
16	DIN 1835-E		ZH16-89-1	0.500 - 8.049	48	63	36	

NEW: Stock Program Type 113

Solid carbide gundrill Type 113

Nose grind: Standard nose grind

Driver: Ø 10x40/55 mm DIN6535-HA10 (ZH10-51)

Uncoated

Ex stock*



DC	25 x D			35 x D			55 x D		
	OAL	Drilling depth	LCF	OAL	Drilling depth	LCF	OAL	Drilling depth	LCF
	Over all length		Flute length	Over all length		Flute length	Over all length		Flute length
1.50	115	38	58	130	53	73	160	83	103
	702 001 100			702 001 101			702 001 102		
1.60	115	40	58	130	56	73	160	88	103
	702 001 103			702 001 104			702 001 105		
2.00	130	50	73	150	70	93	190	110	133
	702 001 106			702 001 107			702 001 108		
2.50	145	63	88	170	88	113	220	138	163
	702 001 109			702 001 110			702 001 111		

*While stock lasts - Subject to prior sale

Nose grind: Standard nose grind

Driver: Ø 10x40/55 mm DIN6535-HA10 (ZH10-51)

XT-coated

Ex stock*

DC	25 x D			35 x D			45 x D			55 x D		
	OAL	Drilling depth	LCF	OAL	Drilling depth	LCF	OAL	Drilling depth	LCF	OAL	Drilling depth	LCF
	Over all length		Flute length	Over all length		Flute length	Over all length		Flute length	Over all length		Flute length
3.00	160	75	103	190	105	133				250	165	193
	702 001 112			702 001 113			702 001 114			702 001 114		
3.50	175	88	118	210	123	153	245	158	188			
	702 001 115			702 001 116			702 001 117			702 001 117		
4.00	185	100	128	225	140	168	265	180	208			
	702 001 118			702 001 119			702 001 120			702 001 120		
5.00	215	125	158	265	175	208	315	225	258			
	702 001 121			702 001 122			702 001 123			702 001 123		
6.00	240	150	183	300	210	243	360	270	303			
	702 001 124			702 001 125			702 001 126			702 001 126		

*While stock lasts - Subject to prior sale

NEW: Stock Program Type 113-HP

Solid carbide gundrill – High Performance tool design

→ Alternative to carbide twist drills

Particularly suitable for the use on **machining centers** (with Emulsion) - Ex stock*

Carbide grade: HP1

Nose grind: < Ø 5.0 = SA-0504 ≥ Ø 5.0 = SA-0503

Driver: Ø 10x40/55 mm DIN6535-HA10 (ZH10-51) from tool dia. 8 mm without driver

TIN-coated

DC	Schaft	20 x D			30 x D			40 x D		
		OAL	Drilling depth	LCF	OAL	Drilling depth	LCF	OAL	Drilling depth	LCF
2.00					145	60	88	165	80	108
		733 000 622			733 000 623					
3.00		150	60	93	180	90	123	210	120	153
		733 000 624			733 000 625			733 000 626		
4.00		170	80	113	210	120	153	250	160	193
		733 000 627			733 000 628			733 000 629		
5.00		195	100	138	245	150	188	295	200	238
		733 002 022			733 002 023			733 002 024		
6.00		215	120	158	275	180	218	335	240	278
		733 002 025			733 002 026			733 002 027		
7.00					310	210	248			
		733 002 184								
8.00	Ø 8 x 40				340	260	300			
		733 001 721								
9.00	Ø 8 x 40	260	180	220						
		733 002 185								
10.00	Ø 10 x 40				380	300	340			
		733 001 720								

*While stock lasts - Subject to prior sale

Particularly suitable for the use on **deep hole drilling machines** (with drilling oil) - Ex stock*

Carbide grade: HP1

Nose grind: SA-0504

Driver: Ø 10x40/55 mm DIN6535-HA10 (ZH10-51)

XT-coated

DC	20 x D			25 x D			40 x D			50 x D			55 x D			60 x D		
	OAL	Drilling depth	LCF	OAL	Drilling depth	LCF	OAL	Drilling depth	LCF	OAL	Drilling depth	LCF	OAL	Drilling depth	LCF	OAL	Drilling depth	LCF
1.5				110	38	53							195	83	138			
	733 002 710			733 002 711														
2.0	115	40	58													195	120	138
	733 002 712			733 002 713														
2.5	130	50	73													230	150	173
	733 002 714			733 002 715														
3.0	145	60	88													265	180	208
	733 002 716			733 002 717														
4.0	175	80	118													335	240	278
	733 002 718			733002719														
5.0	205	100	148				305	200	248				380	275	323			
	733 002 720			733 002 721			733 002 722											
6.0	235	120	178				355	240	298	405	300	348						
	733 002 723			733 002 724			733 002 725											

*While stock lasts - Subject to prior sale

NEW: Express Production Line Type 113

Solid carbide gundrill

The stock program of express line includes the following tools*:

Flute length LCF (mm)					
DC	20 - 52	53 - 77	78 - 100	101 - 157	158 - 237
0.5	X	X	X		
0.55	X	X	X		
0.6	X	X	X		
0.65	X	X	X		
0.7	X	X	X		
0.75	X	X	X		
0.8	X	X	X		
0.85	X	X	X		
0.9		X	X	X	
1		X	X	X	X
1.1		X	X	X	X
1.2		X	X	X	X
1.3		X	X	X	X
1.4		X	X	X	X
1.5		X	X	X	X
1.6		X	X	X	X
1.7		X	X	X	X
1.8		X	X	X	X
1.9		X	X	X	X
2		X	X	X	X
2.1		X	X	X	X
2.2		X	X	X	X
2.3		X	X	X	X
2.4		X	X	X	X
2.5		X	X	X	X
2.6		X	X	X	X
2.7		X	X	X	X
2.8		X	X	X	X
2.9		X	X	X	X
3		X	X	X	X

Intermediate dimensions on request
*While stock lasts - Subject to prior sale

Flute length LCF (mm)					
DC	20 - 52	53 - 77	78 - 100	101 - 157	158 - 237
3.1		X	X	X	X
3.2		X	X	X	X
3.3		X	X	X	X
3.4		X	X	X	X
3.5		X	X	X	X
3.6		X	X	X	X
3.7		X	X	X	X
3.8		X	X	X	X
3.9		X	X	X	X
4		X	X	X	X
4.1		X	X	X	X
4.2		X	X	X	X
4.3		X	X	X	X
4.4		X	X	X	X
4.5		X	X	X	X
4.6		X	X	X	X
4.7		X	X	X	X
4.8		X	X	X	X
4.9		X	X	X	X
5		X	X	X	X
5.1		X	X	X	X
5.2		X	X	X	X
5.3		X	X	X	X
5.4		X	X	X	X
5.5		X	X	X	X
5.6		X	X	X	X
5.7		X	X	X	X
5.8		X	X	X	X
5.9		X	X	X	X
6		X	X	X	X

Intermediate dimensions on request
*While stock lasts - Subject to prior sale

NEW: Express Production Line Type 113

Solid carbide gundrill

Carbide grade: K15
Nose grind: Standard nose grind
Driver:

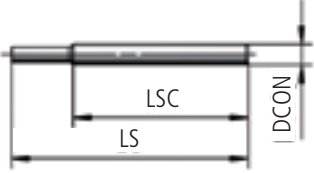
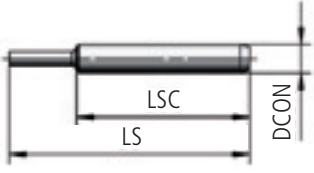
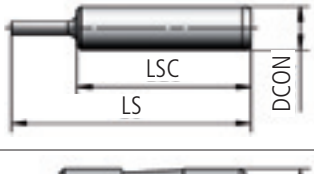
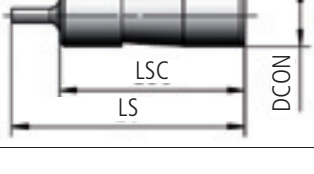
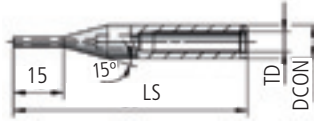
Illustration	Dimension DCONxLSC/LS (mm)	Design	botek- driver	Tool dia. (mm)
	Ø 4 x 34/46	particularly suitable for hydraulic chucks and collets	ZH4-08	0.5 - 5.0 mm
	Ø 6 x 36/50		ZH6-12	0.5 - 4.5 mm
	Ø 10 x 40/55		ZH10-51	0.5 - 6.0 mm
	Ø 12.7 x 38/48		ZH12,7-01	0.5 - 6.0 mm
	Ø 10 x 115/130		VH10-04	0.5 - 6.0 mm

More drivers on request

Delivery time: **Uncoated: max. 5 working days**
TIN-coated: max. 10 working days
XT-coated: max. 10 working days
 (more coatings on request)



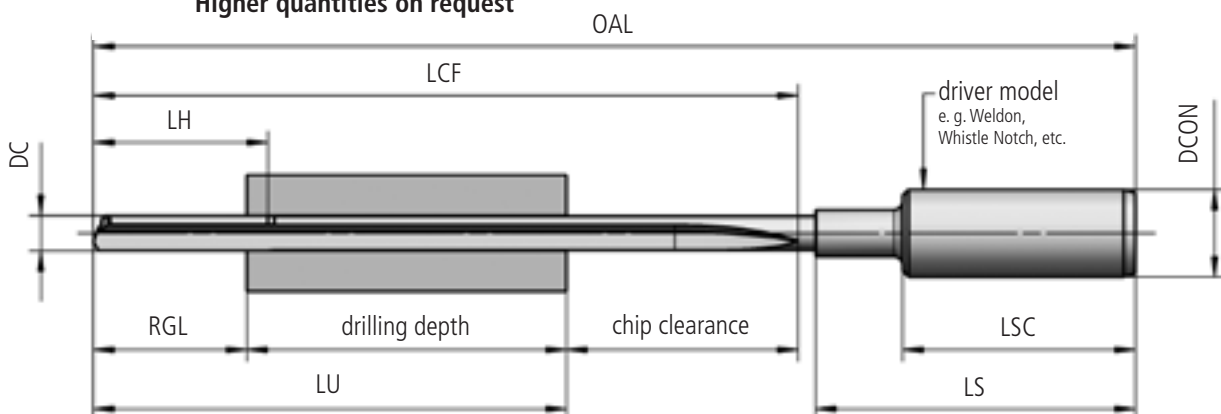





Higher quantities on request



Single flute gundrills with brazed drill head

Type 110/Type 111/Type 112/Type 114/Type 115

Overview

Type	Tool dia.	
Type 110 Single flute gundrill with brazed solid carbide tip	kidney-shaped coolant channel for tool dia. 1.850 - 7.059 mm	
	2 coolant holes for tool dia. 7.060 - 51.200 mm	
Type 111 Single flute gundrill drill head made of a steel body with inserted carbide cutting blade and bearing pads	1 coolant hole for tool dia. 5.800 - 40.009 mm	
	2 coolant holes for tool dia. 40.010 - 60.009 mm (not shown)	
Type 112 Single flute stepped gundrill with solid carbide tip (to produce precise stepped holes in one operation)	kidney-shaped coolant channel or 2 coolant holes depending on diameters tool dia. 2.000 - 51.200 mm	
Type 114 Trepanning gundrill carbide tip for producing annular drill-holes	tool outer dia. 11.000 - 50.000 mm	
Type 115 Single flute counterboring tool with solid carbide tip	kidney-shaped coolant channel or 2 coolant holes depending on diameters tool dia. 2.000 - 51.200 mm	
Typ 115-01 Single flute stepped counterboring tool		
Type 115-03 Single flute counterboring tool with guiding pilot with solid carbide tip		tool dia. 4.000 - 12.000 mm
Type 115-04 Single flute counterboring tool with guiding pilot steel body with inserted carbide cutting blade and bearing pads	tool dia. 12.001 - 60.006 mm	

Tool design

The typical gundrill is fabricated with a drill head section of solid carbide or a steel body with inserted carbide cutting blade and bearing pads. The head section is brazed to a heat treated tube (flute) section then fitted and brazed to a hardened and ground steel driver.

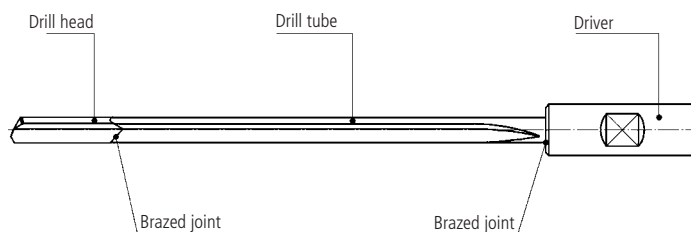

Single flute gundrills with brazed drill head Type 110/Type 111

Drill head

a) Peripheral contour

The single flute gundrill is selfguided while drilling. Guide pads on the drill head act as supports. The layout of the guide pads often has a decisive influence on the surface quality and dimensional accuracy of the drilled hole. Cutting forces press the guide pads against the hole wall with force that a burnishing effect occurs, producing the surface quality and dimensional accuracy (roundness) typical of the gundrilling process.

Various contours (see page 16 + 17) are available to suit your drilling requirements.

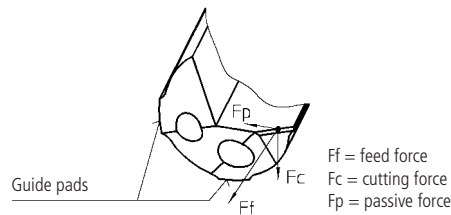

b) Nose grind geometry

The nose grind geometry affect the following, hole tolerance, chip formation, coolant pressure and flow, tool life, centerline deviation and surface quality. Over the years, botek has successfully tested a number of different nose grinds for drilling various materials.

botek's experience has formed the foundation for the development of our standard nose grind geometries. This meets the requirements of most drilling applications. Deep-hole drilling of especially long chipping materials and difficult to machine materials usually call for special nose grind geometries, and in some cases, made to order chip breakers, all available from botek.

Standard nose grinds for Type 110/111	
SA-0001 for drill range 1.850 - 4.000 mm	
SA-0002 for drill range 4.001 - 20.000 mm	
SA-0003 for drill range 20.001 - ... mm	

We are pleased to provide you with regrinding instructions on request.

Single flute gundrills with brazed drill head

Type 110/Type 111/Type 112/Type 01

Solid drilling tools

Drill head design	Solid carbide tip		Steel body with brazed carbide cutting blade and bearing pads		Steel body with indexable carbide inserts and guide pads	
Working method/ tool type	Solid drilling tools					
	Type 110	Type 112 (Step drill)	Type 111		Type 01-000 Type 01-010	
Illustration						
Drilling range from - to (mm)	1.850 - 51.200		5.800 - 60.009		12.000 - 43.990	
Tool length	depending on diameter, max. 5000 mm					
Coolant hole design (standard)	kidney tool dia. 1.850 - 7.059	2-hole tool dia. 7.060 - 51.200	1-hole tool dia. 5.800 - 40.009	2-hole tool dia. 40.010 - 60.009	1-hole tool dia. 12.000 - 43.990	
Advantages	<ul style="list-style-type: none"> - Several peripheral contours are available to suit your drilling applications - Regrindable - Optimum coolant flow due to various coolant channel designs - Available with PCD cutting edge 		<ul style="list-style-type: none"> - Carbide grade of cutting blades may be different than guide pads to suit specific drilling applications - Regrindable - Drill breakage is minimized by the damping effect of drill head body section 		<ul style="list-style-type: none"> - Cost effective for high production - Variety of carbide grades and chip breaker designs available 	
Peripheral contours botek adapts the contour optimally to meet your drilling requirements! Important: Contour EA, G and E are non-micable!	 G (Standard)		 C		Fixed peripheral contour due to tool design	
	 A	 D	 EM			
	 EA	 S				
Special contour	Also available upon special request				see botek brochure: Deep hole drilling tool Type 01/02/07	
Special nose grinds	All tools are also available with special nose grind					
Tool coatings	Please specify the coating you require					
Diamond/PCD	Also available cutting edge with PCD					
					Also available with PCD cutting edge	

Single flute gundrills with brazed drill head Type 114/Type 115

Counterboring/Trepanning tools

Drill head design	Solid carbide tip		Steel body with brazed carbide cutting blade and bearing pads			
Working method/ tool type	Drilling tools		Counterboring tools with guiding pilot		Trepanning tool	
	Type 115	Type 115-01	Type 115-03	Type 115-04	Type 114	
Illustration						
Drilling range from - to (mm)	2.000 - 51.200		4.000 - 12.000	12.001 - 60.006		11.000 - 50.000
Coolant hole design (standard)	kidney tool dia. 1.850 - 7.059	2-hole tool dia. 7.060 - 51.200	1-hole tool dia. 5.800 - 40.009	2-hole tool dia. 40.010 - 60.009	Determined by tool design	
Special features	<ul style="list-style-type: none"> - with round drill tube (chip removal in drilling direction) - with fluted standard drill tube (chip removal against drilling direction) 					
Peripheral contours	<p>G (Standard)</p> <ul style="list-style-type: none"> - All materials - Suitable for nearly all drilling requirements - Close drilling tolerance - Minimal drift 		<p>C</p> <ul style="list-style-type: none"> - Stainless steel, wood - Not easily machinable materials - Preferred for water soluble (emulsion) coolants 		Fixed peripheral contour due to tool design	
<p>botek adapts the contour optimally to meet your drilling requirements!</p> <p>Important: Contour EA, G and E are non-micable!</p>	<p>A</p> <ul style="list-style-type: none"> - Aluminium - Close drilling tolerance 	<p>D</p> <ul style="list-style-type: none"> - Cast iron and graphite - Close drilling tolerance in cast iron 	<p>EM</p> <ul style="list-style-type: none"> - Steel, cast iron - Soft materials 			
<p>EA</p> <ul style="list-style-type: none"> - Steel and aluminium - Crosshole drilling operations - Unfavourable drilling conditions 	<p>S</p> <ul style="list-style-type: none"> - Steel - Close drilling tolerance - Good surface quality - Ideal for short holes 					
Special contour	Also available upon special request		-	-		
Special nose grinds	All tools are also available with special nose grind		-	-		
Tool coatings	Please specify the coating you require		-	-		
Diamant/PCD	Also available to order with PCD point		-	-		

Drill shaft

Tempered alloy steel tubing is formed with a V-shaped groove (flute) to create the swarf (coolant) return channel required for the gundrilling operation. Design considerations for proper drill tube sizes include the ratio between the drill tube outside diameter and inside diameter for optimum torsional rigidity. This ensures exceptional cutting performance, coolant flow and tool life.

With standard gundrills the flute section is typically extended to the driver. For longer gundrills it is possible to have a round section of drill tube with a shorter flute length for added rigidity and strength.

Driver

Type 110/Type 111/Type 112/Type 114/Type 115

Driver

The single flute gundrill is typically provided with a driver for holding the tool in the machine spindle. The driver transmits the torque from the machine spindle. botek manufactures a variety of standard drivers from stock as well as customer specific configurations.

Standard drivers for single flute gundrills with brazed drill head - Overview

Designation		Drawing	botek driver no.	for tool length calculation			X = Notch location	TD = Thread size
Ø dia. (mm)	Type			drill dia. range (mm) from - to	LSC	LS Driver with pin		
10			ZH10-00	1.850 - 7.299	40		24.0	
16			ZH16-03	1.850 - 12.399	45	53	31.0	
25			ZH25-00	6.000 - 19.509	70	78	34.0	
10	with pin		ZH10-01	7.300 - 12.399	40	57	24.0	
16			ZH16-04	12.400 - 20.509	45	72	31.0	
25	with pin and drive key		ZH25-01	19.510 - >	70	105	34.0	
16			ZH16-02	1.850 - 12.399	50	58	47.5	
16	with pin		ZH16-33	12.400 - 20.509	50	77	47.5	
10	GKT with metr. thread		ZH10-06	1.850 - 7.299	60			M6x0.5
16			ZH16-15	1.850 - 12.399	80			M10x1
25			ZH25-08	6.000 - 19.509	100			M16x1.5
10	GKT with metr. thread with pin		ZH10-28	7.300 - 12.399	60	77		M6x0.5
16			ZH16-22	12.400 - 20.509	80	105		M10x1
25			ZH25-10	19.509 - >	100	140		M16x1.5
12.7	1/2"		ZH12.7-00	1.850 - 9.699	38.1		25.3	
19.05	3/4"		ZH19.05-01	3.960 - 14.899	70		45.0	
25.4	1"		ZH25.4-00	6.000 - 19.509	70		57.5	
31.7	1 1/4"		ZH31.7-00	9.700 - 25.609	70		57.5	
38.1	1 1/2"		ZH38.1-00	9.700 - 32.609	70		57.5	
19.05	inch dia. with pin		ZH19.05-11	14.900 - 24.609	70	97	45.0	
25.4			ZH25.4-01	19.510 - >	70	100	57.5	
31.7			ZH31.7-01	25.610 - >	70	110	57.5	
38.1			ZH38.1-01	32.610 - >	70	110	57.5	
10	VDI 3208		ZH10-44	1.850 - 6.749	60	68	35	M6x0.5
16			ZH16-31	1.850 - 10.799	80	90	37	M10x1
25			ZH25-34	6.000 - 19.509	100	112	45	M16x1.5
16	VDI 3208 with pin		ZH16-66	10.800 - 16.399	80	110	37	M10x1
25			ZH25-40	19.510 - 42.699	100	142	45	M16x1.5

Standard drivers for gundrills with brazed drill head - Overview

Designation		Drawing	botek driver no.	for tool length calculation			X = Notch location	TD = Thread size
ø dia. (mm)	Type			drill dia. range (mm) from - to	LSC	LS Driver with pin		
16	Adjustable driver with acme thread		SH16-00	1.850 - 12.899	112		73.0	TR16x1.5
20			SH20-00	1.850 - 14.899	126		82.0	TR20x2
28			SH28-00	6.000 - 21.509	126		82.0	TR28x2
36			SH36-00	8.700 - 28.609	162		109.0	TR36x2
16	Speedbit		ZH16-21	1.850 - 12.399	40		28.0	
25			ZH25-16	6.750 - 19.509	50		35.0	
35			ZH35-00	9.700 - 28.609	60		40.0	
16	Speedbit with pin		ZH16-30	12.400 - 20.509	40	67	28.0	
25			ZH25-20	19.510 - 30.609	50	77	35.0	
35			ZH35-01	28.610 - >	60	100	40.0	
10	DIN 6535-HA		ZH10-40	1.850 - 7.299	40			
12			ZH12-18	1.850 - 8.999	45			
16			ZH16-11	1.850 - 12.399	48			
20			ZH20-01	5.000 - 15.899	50			
25			ZH25-11	6.000 - 19.509	56			
32	DIN 1835-A40		ZH32-24	9.700 - 25.600	60			
40			ZH40-03	9.700 - 32.609	70			
10	DIN 6535-HA or 1835-A with pin		ZH10-41	7.300 - 12.399	40	57		
12			ZH12-19	9.000 - 15.899	45	62		
16			ZH16-20	12.400 - 20.509	48	75		
20			ZH20-60	15.900 - 25.603	50	77		
25			ZH25-21	19.510 - 42.699	56	86		
32			ZH32-23	25.610 - 45.699	60	100		
40	ZH40-04	32.610 - >	70	110				
10	DIN 6535-HB		ZH10-11	1.850 - 7.299	40		23.5	
12			ZH12-07	1.850 - 8.999	45		26.5	
16			ZH16-32	1.850 - 12.399	48		29.0	
20			ZH20-29	1.850 - 15.899	50		30.5	
25	DIN 6535-HB		ZH25-22	6.000 - 19.509	56		38.0	
32	DIN 1835-B32		ZH32-10	9.700 - 25.609	60		43.0	
40	DIN 1835-B40		ZH40-13	9.700 - 32.609	70		47.0	
50	DIN 1835-B50	ZH50-05	15.900 - 42.699	80		54.0		
10	DIN 6535-HB or 1835-B with pin		ZH10-23	7.300 - 12.399	40	57	23.5	
12			ZH12-02	9.000 - 15.899	45	62	26.5	
16			ZH16-53	12.400 - 20.509	48	75	29.0	
20			ZH20-34	15.900 - 25.609	50	77	30.5	
25			ZH25-31	19.510 - >	56	86	38.0	
32			ZH32-11	25.610 - >	60	100	43.0	
40			ZH40-14	32.610 - >	70	110	47.0	
50			ZH50-06	42.700 - >	80	120	54.0	
10	DIN 1835-E		ZH10-20	1.850 - 7.299	40		28.0	
12			ZH12-08	1.850 - 8.999	45		33.0	
16			ZH16-47	1.850 - 12.399	48		36.0	
20			ZH20-40	1.850 - 15.899	50		38.0	
25			ZH25-36	6.000 - 19.509	56		44.0	
32			ZH32-12	9.700 - 25.609	60		48.0	
40			ZH40-18	9.700 - 32.609	70		66.0	
50			ZH50-04	15.900 - 42.699	80		77.0	
10	DIN 1835-E with pin		ZH10-24	7.300 - 12.399	40	57	28.0	
12			ZH12-05	9.000 - 15.899	45	62	33.0	
16			ZH16-51	12.400 - 20.509	48	75	36.0	
20			ZH20-43	15.900 - 29.609	50	77	38.0	
25			ZH25-37	19.510 - >	56	86	44.0	
32			ZH32-13	25.610 - >	60	100	48.0	
40			ZH40-17	32.610 - >	70	110	66.0	
10	DIN 6535-HE		ZH10-29	1.850 - 7.299	40		28.0	
12			ZH12-13	1.850 - 8.999	45		33.0	
16			ZH16-62	1.850 - 12.399	48		36.0	
20			ZH20-55	1.850 - 15.899	50		38.0	
10	DIN 6535-HE with pin		ZH10-30	7.300 - 12.399	40	57	28.0	
12			ZH12-14	9.000 - 15.899	45	62	33.0	
16			ZH16-70	12.400 - 20.509	48	75	36.0	
20			ZH20-56	15.900 - 29.609	50	77	38.0	

NEW: Stock program Type 110

Single flute gundrill with brazed carbide tip

Version: Single flute gundrill Type 110 **with driver Ø 10 x 40 mm (ZH10-00)**
Carbide grade: K15
Guide form: G
Standard nose grind: SA-0001 (40°/30°)

Drill-Ø	Order No. for over all length									
	200 mm	300 mm	400 mm	500 mm	600 mm	800 mm	1000 mm	1200 mm	1300 mm	1500 mm
3.00	702 000 100	702 000 102								
Flute length	158	220	320	420	520	720	920	1120	1220	1420

While stock lasts - Subject to prior sale

Version: Single flute gundrill Type 110 **with driver Ø 25 x 70/78 mm (ZH25-00)**
 For the * marked items the flute length changes due to the use of a driver with brazing pin (25 x 70/105 [ZH25-01])
Carbide grade: K15
Guide form: G
Standard nose grind: SA-0001 (40°/30°) for drills Ø 4.0 mm
 SA-0002 (30°/20°) for drills Ø 5.0 mm bis 20.0 mm
 SA-0003 (20°/15°) for drills from Ø 22.0 mm

Drill-Ø	Order No. for over all length									
	200 mm	300 mm	400 mm	500 mm	600 mm	800 mm	1000 mm	1200 mm	1300 mm	1500 mm
4.00	702 000 101	702 000 103	702 000 107	702 000 123						
5.00		702 000 104	702 000 108	702 000 124	702 000 133	702 000 150	702 000 165			
6.00		702 000 105	702 000 109	702 000 125	702 000 134	702 000 151	702 000 166			
6.50			702 000 110			702 000 152	702 000 167	702 000 184		
7.00		702 000 106	702 000 111	702 000 126	702 000 135	702 000 153	702 000 168			702 000 195
8.00			702 000 112	702 000 127	702 000 136	702 000 154	702 000 169	702 000 185		702 000 196
8.50			702 000 113			702 000 155	702 000 170	702 000 186		
9.00			702 000 114	702 000 128	702 000 137	702 000 156	702 000 171			
10.00			702 000 115	702 000 129	702 000 138	702 000 157	702 000 172	702 000 187	702 000 189	702 000 197
11.00			702 000 116	702 000 130	702 000 139	702 000 158	702 000 173			
12.00			702 000 117	702 000 131	702 000 140	702 000 159	702 000 174		702 000 190	702 000 198
13.00			702 000 118	702 000 132	702 000 141		702 000 175		702 000 191	
14.00			702 000 119		702 000 142	702 000 160	702 000 176		702 000 192	
15.00			702 000 120		702 000 143	702 000 161	702 000 177		702 000 193	702 000 199
16.00			702 000 121		702 000 144	702 000 162	702 000 178	702 000 188	702 000 194	702 000 200
18.00			702 000 122		702 000 145	702 000 163	702 000 179			702 000 201
19.00					702 000 146	702 000 164	702 000 180			702 000 202
20.00*					702 000 147*		702 000 181*			702 000 203*
22.00*					702 000 148*		702 000 182*			
25.00*					702 000 149*		702 000 183*			702 000 204*
Flute length	120	220	320	420	520/490*	720	920/890*	1120	1220	1420/1390*

While stock lasts - Subject to prior sale

NEW: Stock program Type 110

Single flute gundrill with brazed carbide tip

Delivery time:	1 - 3 working days
Version:	Gundrill Type 110, according to customer – please see table
Carbide grade:	K15
Guide form:	G
Standard nose grind:	SA-0001 (40°/30°) for drills Ø 3.0 mm and 4.0 mm SA-0002 (30°/20°) for drills Ø 5.0 mm up to 20.0 mm SA-0003 (20°/15°) for drills from Ø 22.0 mm

Drill-Ø	Flute length (mm)									
	155	240	340	440	540	740	940	1140	1240	1440
3.00										
4.00										
5.00										
6.00										
6.50								1140		
7.00										1440
8.00								1140		
8.50										
9.00										
10.00								1140	1240	1440
11.00										
12.00										1440
13.00										
14.00									1240	
15.00										
16.00										
18.00								1140		1440
19.00										
20.00*										1410
22.00*						510		910		
25.00*										1410

* For the marked items the flute length changes due to the use of a driver with brazing pin.

The following standard drivers are available:

Dimensions [mm]	DIN	botek driver
Ø 10 x 40	DIN 6535 HA, cylindrical	ZH10-40
Ø 25 x 56		ZH25-11
Ø 10 x 40	DIN 1835 B, Weldon	ZH10-11
Ø 25 x 56		ZH25-22
Ø 10 x 40	DIN 1835 E, Whistle Notch	ZH10-20
Ø 25 x 56		ZH25-36

Please note:

Over all length = Flute length + 5 mm + total length driver

Express Order Line Type 110/Type 111/Type 112/Type 115

Single flute gundrill with brazed carbide tip

With the "botek EXPRESS PRODUCTION LINE" we can manufacture tools, which are not included in our Stock Program, in a very short time.

Type 110

Single flute gundrill

with brazed solid carbide tip kidney-shaped coolant channel

1 coolant hole – diameter range: 1.850 - 7.059 mm

2 coolant holes – diameter range: 7.060 - 51.200 mm



Type 111

Single flute gundrill

drill head made of a steel body with inserted carbide cutting blade and bearing pads

1 coolant hole – diameter range: 5.800 - 40.009 mm

2 coolant holes – diameter range: 40.010 - 60.009 mm



Type 112

Single flute stepped gundrill

with solid carbide tip (to produce precise stepped holes in one operation) Kidney-shaped

coolant channel or 2 coolant holes depending on tool diameter

diameter range: 2.000 - 51.200 mm



Type 115

Single flute counterboring tool

with solid carbide tip, chips forward (round tube)

diameter range: 2.000 - 51.200 mm



→ You can order by fax or e-mail

→ Please see our order form on page 23.

FAX to +49 7123 3808 138

Inquiry

Order (please mark with a cross where applicable)

Customer ID: _____	Order No: _____
Address: _____	Shipping address: _____
_____	_____
_____	_____
Name Besteller: _____	Phone: _____

Drilling method: Solid drilling Counterboring

Material: Steel GG/GGG AL-Si-Leg _____

Machine: Machining center Deep hole drilling machine

Ø (DC)	Length (OAL)	Drilling depth (mm)	Driver dimensions (DCONxLSC/LS)	Driver No.	Coating	Pieces	Delivery date

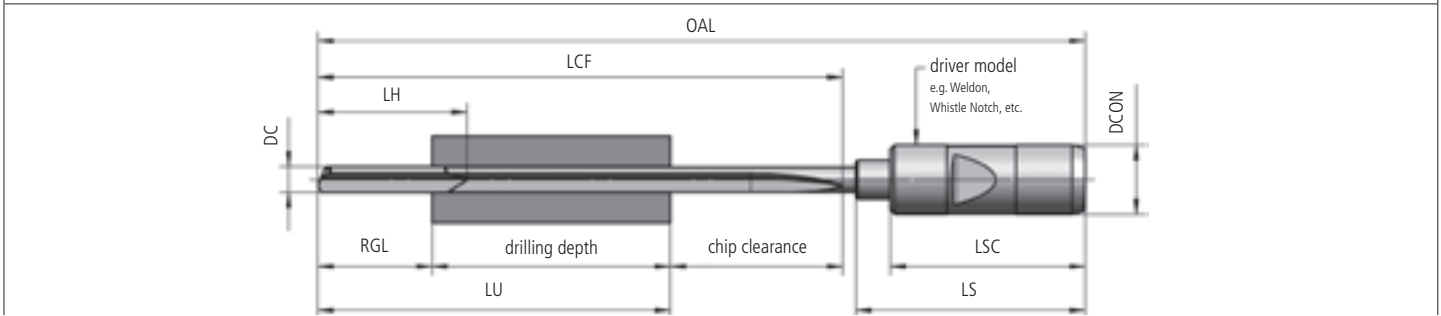
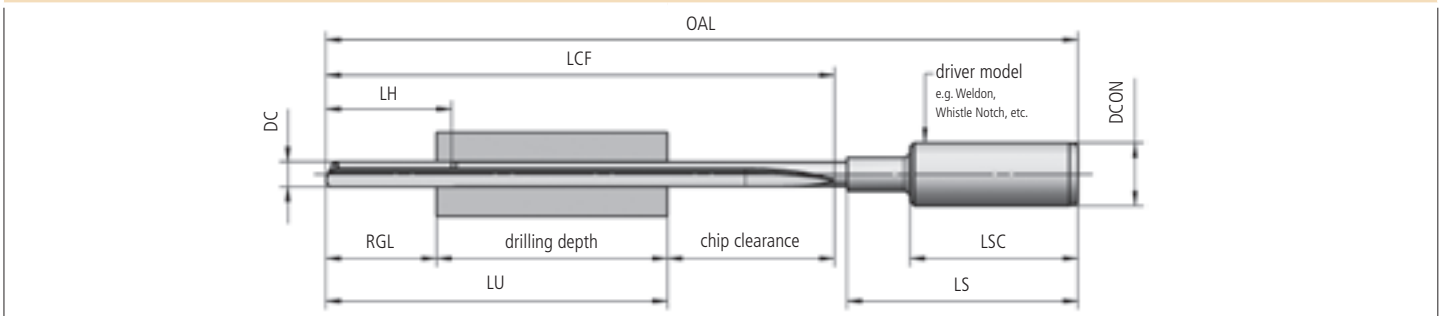

- Type 113 Single flute gundrill in solid carbide design - Standard version
- Type 113-HP Solid carbide gundrill - High performance tool design
- Type 110 Single flute gundrill with brazed carbide tip

A surcharge will be applied depending on delivery requirement. You will be notified to this change prior to production. The number of tools for express orders is limited.

Note: _____

Mode of shipment: UPS (delivery within 2 working days) TNT 9:00 a.m.

TNT 12:00 a.m. Pick up

Date: _____ Signature: _____

Technical Information

Drilling quality

To achieve optimum drilling results when using **carbide tipped or solid carbide gundrills**, various criteria must be applied. In addition to tool design, key factors are machine design and construction, process techniques, pressurized and filtered deep hole drilling coolant. Selection of proper cutting parameters is also a significant factor.

The key factors botek considers when designing gundrills:

- Material type
- Diameter, tolerance and surface finish
- Peripheral contour
- Carbide grade and coating
- Nose grind geometry

In addition to our refined manufacturing and technology for consistent product quality, our application and technical experience help you realize optimal solutions.

Achievable drilling tolerances

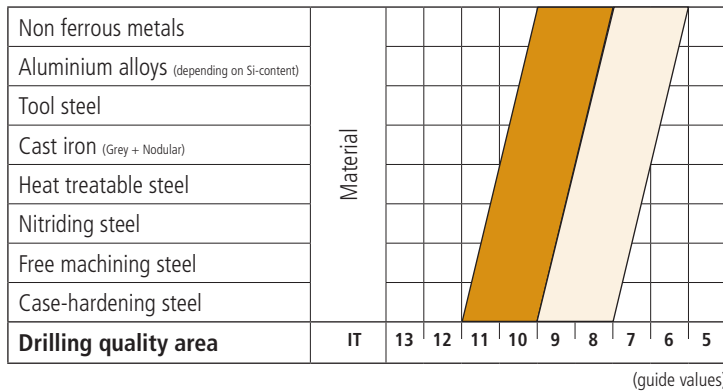

under normal conditions
 under favourable conditions

Surface quality

Roughness class		N8	N7	N6	N5	N4	N3
Quality area							
Surface roughness values	Rt μm	21	11.5	6.2	3.4	1.9	1.0
	Ra μm	3.2	1.6	0.8	0.4	0.2	0.1
	Rz μm	14	7.6	4.5	2.2	1.2	0.65

(guide values)

under normal conditions
 under favourable conditions

Centerline deviation (drift)

Counter-rotation: The optimum results are achieved with rotating tool and simultaneous workpiece counter-rotation: See "Z"

Workpiece rotating: The next best technique involves the workpiece rotating with the gundrill non-rotating: See "Y"

Tool rotating: See "X"

In all applications tool drift is minimized by using a close fitting pilot bore or guide bushing during gundrilling. Angular alignment of pilot bore with desired gundrill bore is imperative.

With a guide bushing, alignment and distance from the workpiece are also important.

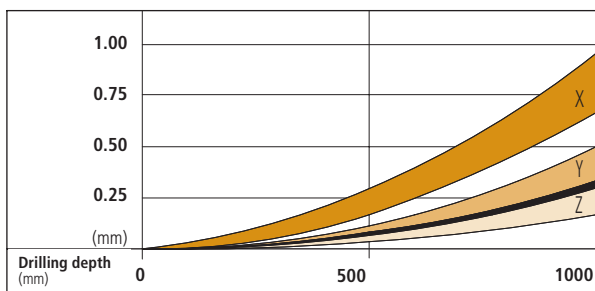

The data above is based on single flute carbide tipped gundrills. Achieved results may be improved using single flute solid carbide gundrills.

Hole straightness

Whipping or deflection of the gundrill flute plays a decisive role in hole straightness and run out in the workpiece.

Carbide tipped gundrills must be supported by a steady rest or whip guide every 40 diameters.

For further information, refer to page 32 and 33.

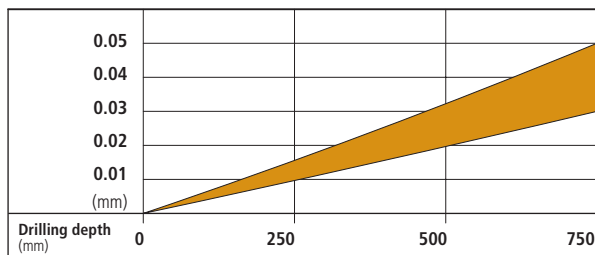

Roundness

Hole roundness is a primary advantage of gundrilling over conventional twist drilling.

Hole roundness measurements as low as 3 μm are possible.

Technical Information

Guide values Type 113

Guide values for gundrilling of various materials with solid carbide gundrills

(Guide values Type 113-HP refer to page 28 and 29)

Material groups	Structural steel Carbon steel Low alloyed steel Case hardening steel < 900 N/mm ² "free machining"	Alloyed tempered steel Case hardening steel Nitriding steel Tool steel > 900 N/mm ²	Stainless steel (ferritic/martensitic) 13-25% Cr (sulphurized)	Stainless steel corrosion and heat resisting (austenitic) Ni > 8%, 18-25% Cr
Cutting speed m/min	70 - 80	60 - 70	40 - 50	30 - 40
Drill dia. (mm)	Feed rate (mm)/rev.			
	from - to	from - to	from - to	from - to
0.5 - 0.59	0.0002 - 0.0010	0.0003 - 0.0008	0.0004 - 0.0007	0.0002 - 0.0007
0.6 - 0.69	0.0002 - 0.0011	0.0005 - 0.0010	0.0004 - 0.0008	0.0003 - 0.0008
0.7 - 0.79	0.0003 - 0.0014	0.0007 - 0.0012	0.0006 - 0.0010	0.0005 - 0.0010
0.8 - 0.89	0.0004 - 0.0017	0.0010 - 0.0016	0.0007 - 0.0014	0.0007 - 0.0012
0.9 - 0.99	0.0007 - 0.0020	0.0009 - 0.0020	0.0009 - 0.0019	0.0011 - 0.0017
1.0 - 1.09	0.0010 - 0.0026	0.0010 - 0.0026	0.0012 - 0.0024	0.0014 - 0.0020
1.1 - 1.19	0.0014 - 0.0035	0.0013 - 0.0032	0.0015 - 0.0028	0.0016 - 0.0023
1.2 - 1.39	0.0018 - 0.0045	0.0015 - 0.0041	0.0020 - 0.0033	0.0020 - 0.0028
1.4 - 1.59	0.0021 - 0.0060	0.0021 - 0.0052	0.0025 - 0.0042	0.0025 - 0.0036
1.6 - 1.79	0.0028 - 0.0079	0.0024 - 0.0066	0.0031 - 0.0054	0.0032 - 0.0045
1.8 - 1.99	0.0030 - 0.0100	0.0030 - 0.0081	0.0039 - 0.0065	0.0040 - 0.0057
2.0 - 2.49	0.0040 - 0.0130	0.0040 - 0.0100	0.0050 - 0.0080	0.0050 - 0.0070
2.5 - 2.99	0.0060 - 0.0170	0.0050 - 0.0140	0.0080 - 0.0120	0.0080 - 0.0100
3.0 - 3.99	0.0080 - 0.0210	0.0070 - 0.0180	0.0120 - 0.0160	0.0110 - 0.0140
4.0 - 4.99	0.0120 - 0.0290	0.0080 - 0.0270	0.0170 - 0.0220	0.0160 - 0.0200
5.0 - 5.99	0.0150 - 0.0370	0.0120 - 0.0350	0.0240 - 0.0300	0.0230 - 0.0260
6.0 - 7.99	0.0200 - 0.0460	0.0170 - 0.0450	0.0330 - 0.0390	0.0310 - 0.0340
8.0 - 9.99	0.0240 - 0.0610	0.0210 - 0.0620	0.0430 - 0.0510	0.0400 - 0.0440
10.0 - 12.00	0.0300 - 0.0780	0.0270 - 0.0790	0.0550 - 0.0640	0.0500 - 0.0560
Deep-hole drilling oil	highly suitable			
Emulsion	suitable at limited degree			unsuitable
MQL	suitable at limited degree			

Cutting speed and feed rate are dependent on tool length, coolant type and material being drilled, as well as the stability of the drilling machine and workpiece clamping. All figures specified are guide values.

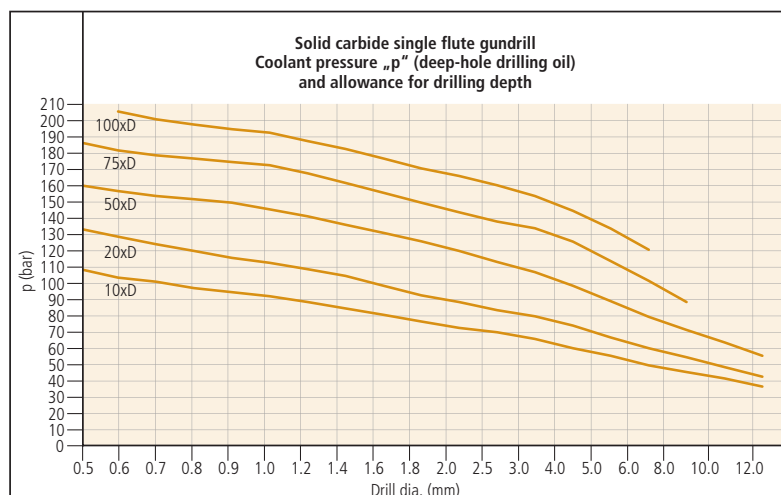

For measuring the exact coolant pressure we recommend the botek coolant pressure gauging kit. For information please refer to page 39.

Guide values for gundrilling of various materials with solid carbide gundrills

Spring steel Hardened steel Hardened steel castings Heat resisting steel Titanium, Ti-alloys Special alloys: Inconel, Nimonic, etc.	Cast iron Grey cast iron (< 300 N/mm ²) Nodular cast iron (< 400 N/mm ²) Malleable cast iron	Cast iron Grey cast iron (> 300 N/mm ²) Nodular graphite iron (> 400 N/mm ²) Steel castings	Copper Bronze Brass Plastics	Aluminium + Aluminium alloys Si-content > 5% "easily workable"	Aluminium + Aluminium alloys Si-content < 5% "not hardened"
25 - 50	80 - 90	60 - 70	90 - 130	120 - 180	100 - 300
Feed rate (mm)/rev.					
from - to	from - to	from - to	from - to	from - to	from - to
0.0001 - 0.0005	0.0005 - 0.0007	0.0004 - 0.0006	0.0001 - 0.0006	0.0003 - 0.0008	0.0002 - 0.0008
0.0002 - 0.0007	0.0006 - 0.0010	0.0005 - 0.0009	0.0003 - 0.0008	0.0004 - 0.0010	0.0002 - 0.0010
0.0004 - 0.0010	0.0007 - 0.0013	0.0007 - 0.0011	0.0004 - 0.0010	0.0006 - 0.0011	0.0003 - 0.0012
0.0004 - 0.0014	0.0010 - 0.0017	0.0009 - 0.0014	0.0007 - 0.0013	0.0007 - 0.0014	0.0003 - 0.0013
0.0006 - 0.0018	0.0014 - 0.0022	0.0013 - 0.0018	0.0010 - 0.0017	0.0010 - 0.0023	0.0004 - 0.0015
0.0007 - 0.0022	0.0018 - 0.0028	0.0018 - 0.0023	0.0015 - 0.0022	0.0013 - 0.0029	0.0005 - 0.0019
0.0009 - 0.0026	0.0023 - 0.0037	0.0024 - 0.0029	0.0020 - 0.0027	0.0017 - 0.0043	0.0007 - 0.0021
0.0012 - 0.0030	0.0031 - 0.0049	0.0031 - 0.0040	0.0024 - 0.0037	0.0022 - 0.0077	0.0009 - 0.0027
0.0016 - 0.0037	0.0039 - 0.0070	0.0047 - 0.0058	0.0030 - 0.0052	0.0027 - 0.0114	0.0011 - 0.0033
0.0020 - 0.0045	0.0048 - 0.0093	0.0064 - 0.0076	0.0035 - 0.0083	0.0037 - 0.0194	0.0013 - 0.0041
0.0025 - 0.0054	0.0058 - 0.0124	0.0070 - 0.0100	0.0041 - 0.0120	0.0050 - 0.0352	0.0016 - 0.0049
0.0030 - 0.0060	0.0080 - 0.0160	0.0100 - 0.0140	0.0050 - 0.0170	0.0080 - 0.0660	0.0020 - 0.0060
0.0050 - 0.0090	0.0100 - 0.0230	0.0130 - 0.0220	0.0070 - 0.0290	0.0110 - 0.0960	0.0030 - 0.0090
0.0080 - 0.0110	0.0150 - 0.0300	0.0150 - 0.0310	0.0090 - 0.0460	0.0180 - 0.1270	0.0050 - 0.0150
0.0110 - 0.0170	0.0200 - 0.0440	0.0200 - 0.0430	0.0110 - 0.0680	0.0250 - 0.1790	0.0080 - 0.0270
0.0140 - 0.0210	0.0250 - 0.0600	0.0250 - 0.0570	0.0140 - 0.0890	0.0340 - 0.2340	0.0110 - 0.0400
0.0190 - 0.0260	0.0360 - 0.0750	0.0300 - 0.0710	0.0190 - 0.1110	0.0500 - 0.2930	0.0180 - 0.0550
0.0250 - 0.0360	0.0480 - 0.1030	0.0400 - 0.0960	0.0240 - 0.1500	0.0690 - 0.4050	0.0250 - 0.0780
0.0300 - 0.0460	0.0600 - 0.1320	0.0600 - 0.1220	0.0290 - 0.1900	0.0900 - 0.5130	0.0340 - 0.1050
highly suitable					
unsuitable					suitable at limited degree
suitable at limited degree					
Cutting speed and feed rate are dependent on tool length, coolant type and material being drilled, as well as the stability of drilling machine and workpiece clamping. All figures specified are guide values.					

The required **viscosity of the deep-hole drilling oil** for a drill diameter of 0.5 to 1.5 mm is approx. 8 - 10 mm²/s (50 SUS) at 40°C and 10 - 15 mm²/s (60 SUS) at drill diameters > 1.5 mm.

When using emulsion, the specified pressures (p) may be reduced by 10 - 20 %.

Coolant filtration of 5 to 10 microns, or better, is required for drill diameters < 2.0 mm.

Coolant filtration of 5 to 20 microns, or better, is required for drill diameters ≥ 2.0 mm.

Guide values for minimum coolant quantity/volumetric flow rate "Q" at specified pressure "p" (bar):

Flow capacity of coolant pump: drill dia. (mm) ≤ 2.0 → min. 4 l/min
Flow capacity of coolant pump: drill dia. (mm) 2.0 - 12.0 → min. 24 l/min

Reliable chip removal is only assured if sufficient coolant is supplied to the tool cutting tip. The diagram shows our recommendation with regards to coolant pressure as a function of drill diameter and drilling depth.

Technical Information

Guide values Type 113-HP

Guide values for gundrilling of various materials with solid carbide gundrill Type 113-HP

Material groups	Structural steel, Free-cutting steel ($< 750 \text{ N/mm}^2$)	Alloyed steel, Case hardening steel ($< 900 \text{ N/mm}^2$)	Tempered steel, Tool steel, Nitriding steel ($< 1200 \text{ N/mm}^2$)	Stainless steel + steel castings Ni $< 8\%$ "easy to machine"
Cutting speed m/min	80	70	65	50
Drill dia. (mm)	Feed rate (mm)/rev.			
	to 25xD = 100%, to 35xD = 90%, to 45xD = 80%, to 55xD = 70%, to 65xD = 60%, to 75xD = 50%, to 80xD = 45%, > 80xD = 40%			
< 1.40	to 0.050	to 0.045	to 0.040	to 0.025
1.41 - 1.60	0.060	0.057	0.054	0.030
1.61 - 1.80	0.070	0.066	0.063	0.035
1.81 - 2.00	0.080	0.076	0.072	0.040
2.01 - 2.25	0.090	0.085	0.081	0.045
2.26 - 2.50	0.100	0.095	0.090	0.050
2.51 - 2.75	0.110	0.105	0.099	0.055
2.76 - 3.00	0.120	0.115	0.108	0.060
3.01 - 3.50	0.135	0.127	0.120	0.067
3.51 - 4.00	0.145	0.138	0.131	0.073
4.01 - 4.50	0.160	0.152	0.144	0.080
4.51 - 5.00	0.174	0.165	0.156	0.087
5.01 - 5.50	0.185	0.176	0.167	0.093
5.51 - 6.00	0.200	0.190	0.180	0.100
6.01 - 6.50	0.210	0.199	0.189	0.105
6.51 - 7.00	0.220	0.209	0.198	0.110
7.01 - 7.50	0.230	0.218	0.200	0.115
7.51 - 8.00	0.240	0.228	0.205	0.120
8.01 - 8.50	0.250	0.237	0.210	0.125
8.51 - 9.00	0.260	0.247	0.220	0.130
9.01 - 12.00	0.260	0.247	0.220	0.130
Deep-hole drilling oil	highly suitable			
Emulsion				suitable at limited degree
MQL				

Cutting speed and feed rate are dependent on tool length, coolant type and material being drilled, as well as the stability of the drilling machine and workpiece clamping. All figures specified are guide values.

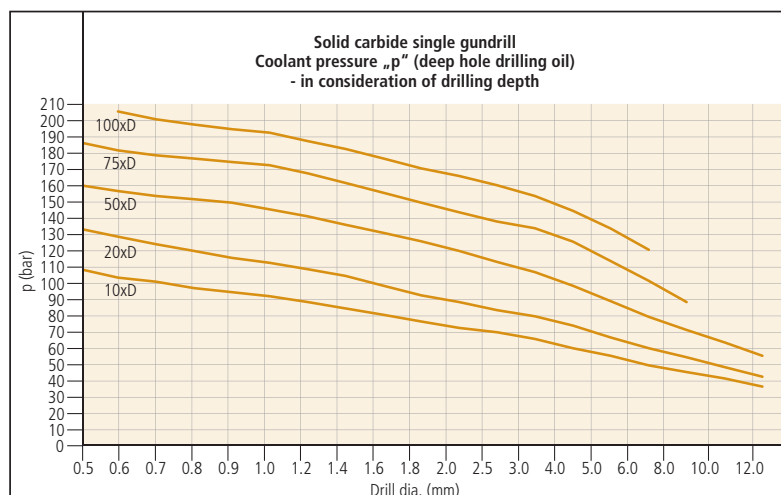

For measuring the exact coolant pressure we recommend the botek coolant pressure gauging kit. For information please refer to page 39.

Guide values for gundrilling of various materials with carbide tipped gundrill Type 113

Stainless steel corrosion and heat resisting (austenitic) Ni > 8%	Spring steel Hardened steel castings Heat resisting steel Special alloys: Inconel, Nimonic, Titanium	Cast iron Steel castings	Copper Bronze Brass Plastics	Aluminium + Aluminium alloys
40	40	90	120	150
Feed rate (mm)/rev.				
to 25xD = 100%, to 35xD = 90%, to 45xD = 80%, to 55xD = 70%, to 65xD = 60%, to 75xD = 50%, to 80xD = 45%, > 80xD = 40%				
to 0.0100	to 0.0100	to 0.050	to 0.060	to 0.060
0.0150	0.0150	0.060	0.075	0.075
0.0175	0.0175	0.070	0.087	0.087
0.0200	0.0200	0.080	0.100	0.100
0.0225	0.0225	0.090	0.112	0.112
0.0250	0.0250	0.100	0.125	0.125
0.0275	0.0275	0.110	0.137	0.137
0.0300	0.0300	0.120	0.150	0.150
0.0335	0.0335	0.135	0.167	0.167
0.0365	0.0365	0.145	0.182	0.182
0.0400	0.0400	0.160	0.200	0.200
0.0435	0.0435	0.174	0.217	0.217
0.0465	0.0465	0.185	0.230	0.230
0.0500	0.0500	0.200	0.250	0.250
0.0525	0.0525	0.210	0.265	0.265
0.0550	0.0550	0.220	0.275	0.275
0.0575	0.0575	0.230	0.287	0.287
0.0600	0.0600	0.240	0.300	0.300
0.0625	0.0625	0.250	0.312	0.312
0.0650	0.0650	0.260	0.320	0.320
0.0650	0.0650	0.260	0.320	0.320
unsuitable		highly suitable		
suitable at limited degree				
Cutting speed and feed rate are dependent on tool length, coolant type and material being drilled, as well as the stability of drilling machine and workpiece clamping. All figures specified are guide values.				

The required **viscosity of the deep-hole drilling oil** for a drill diameter of 0.5 to 1.5 mm is approx. 8 - 10 mm²/s (50 SUS) at 40°C and 10 - 15 mm²/s (60 SUS) at drill diameters > 1.5 mm.

When using emulsion, the specified pressures (p) may be reduced by 10 - 20 %.

Coolant filtration of 5 to 10 microns, or better, is required for drill diameters < 2.0 mm.

Coolant filtration of 5 to 20 microns, or better, is required for drill diameters ≥ 2.0 mm.

Guide values for minimum coolant quantity/volumetric flow rate "Q" at specified pressure "p" (bar):

Flow capacity of coolant pump: drill dia. (mm) ≤ 2.0 → min. 4 l/min
Flow capacity of coolant pump: drill dia. (mm) 2.0 - 12.0 → min. 24 l/min

Reliable chip removal is only assured if sufficient coolant is supplied to the tool cutting tip. The diagram shows our recommendation with regards to coolant pressure as a function of drill diameter and drilling depth.

Technical Information

Guide values Type 110/Type 111

Guide values for gundrilling of various materials with carbide tipped gundrill

Material groups	Structural steel Carbon steel Low alloyed steel Case hardening steel < 900 N/mm ² (265HB) "free machining"	Alloyed tempered steel Case hardening steel Nitriding steel Tool steel > 900 N/mm ² (265HB)	Stainless steel (ferritic/martensitic) 13-25% Cr (sulphurized)	Stainless steel corrosion and heat resisting (austenitic) 18-25% Cr Ni > 8%
Cutting speed m/min	70 - 100	60 - 80	40 - 80	30 - 60
Drill dia. (mm)	Feed rate (mm)/rev.			
	from - to	from - to	from - to	from - to
1.85 - 2.49	0.0019 - 0.0060	0.0019 - 0.0078	0.0019 - 0.0039	0.0016 - 0.0029
2.50 - 2.99	0.0025 - 0.0094	0.0033 - 0.0119	0.0038 - 0.0064	0.0025 - 0.0046
3.00 - 3.49	0.0034 - 0.0128	0.0053 - 0.0157	0.0049 - 0.0089	0.0037 - 0.0063
3.50 - 3.99	0.0045 - 0.0165	0.0070 - 0.0196	0.0070 - 0.0122	0.0050 - 0.0081
4.00 - 4.49	0.0056 - 0.0211	0.0089 - 0.0236	0.0080 - 0.0157	0.0070 - 0.0098
4.50 - 4.99	0.0069 - 0.0254	0.0102 - 0.0274	0.0098 - 0.0189	0.0089 - 0.0118
5.00 - 5.99	0.0089 - 0.0295	0.0125 - 0.0316	0.0118 - 0.0222	0.0113 - 0.0136
6.00 - 6.99	0.0110 - 0.0364	0.0150 - 0.0393	0.0143 - 0.0276	0.0140 - 0.0170
7.00 - 7.99	0.0133 - 0.0431	0.0175 - 0.0467	0.0163 - 0.0343	0.0160 - 0.0205
8.00 - 8.99	0.0157 - 0.0495	0.0200 - 0.0550	0.0183 - 0.0405	0.0180 - 0.0243
9.00 - 9.99	0.0184 - 0.0565	0.0225 - 0.0632	0.0212 - 0.0466	0.0200 - 0.0283
10.00 - 11.99	0.0230 - 0.0630	0.0250 - 0.0710	0.0260 - 0.0530	0.0250 - 0.0320
12.00 - 13.99	0.0270 - 0.0760	0.0310 - 0.0860	0.0320 - 0.0650	0.0300 - 0.0410
14.00 - 15.99	0.0320 - 0.0900	0.0350 - 0.1020	0.0380 - 0.0770	0.0350 - 0.0500
16.00 - 17.99	0.0360 - 0.1030	0.0390 - 0.1190	0.0450 - 0.0900	0.0410 - 0.0590
18.00 - 19.99	0.0410 - 0.1160	0.0440 - 0.1350	0.0530 - 0.1050	0.0480 - 0.0710
20.00 - 23.99	0.0510 - 0.1300	0.0490 - 0.1530	0.0680 - 0.1190	0.0600 - 0.0830
24.00 - 27.99	0.0600 - 0.1570	0.0540 - 0.1850	0.0830 - 0.1430	0.0730 - 0.1060
28.00 - 31.99	0.0700 - 0.1840	0.0590 - 0.2170	0.1000 - 0.1680	0.0870 - 0.1270
32.00 - >	0.0850 - 0.2110	0.0630 - 0.2470	0.1250 - 0.1930	0.1070 - 0.1510
Deep-hole drilling oil	highly suitable			
Emulsion	suitable at limited degree			unsuitable
MQL	suitable at limited degree			

Cutting speed and feed rate are dependent on tool length, coolant type and material being drilled, as well as the stability of the drilling machine and workpiece clamping. All figures specified are guide values.

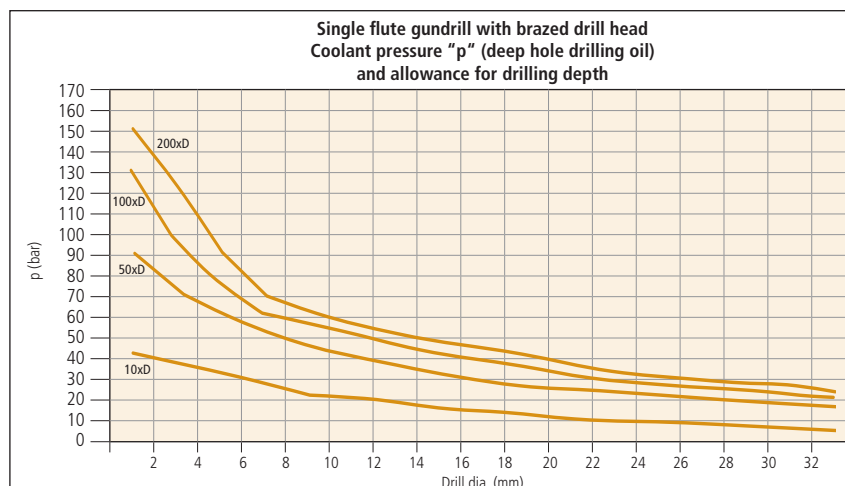

For measuring the exact coolant pressure we recommend the botek coolant pressure gauging kit. For information please refer to page 39.

Guide values for gundrilling of various materials with carbide tipped gundrill

Spring steel Hardened steel Hardened steel castings Heat resisting steel Titanium, Ti - alloys Special alloys: Inconel, Nimonic, etc.	Cast iron Grey cast iron < 300 N/mm ² Nodular cast iron < 400 N/mm ² Malleable cast iron	Cast iron Grey cast iron > 300 N/mm ² Nodular graphite iron > 400 N/mm ² Steel castings	Copper Bronze Brass Plastics	Aluminium + Aluminium alloys Si-content > 5% "easily workable"	Aluminium + Aluminium alloys Si-content < 5%
25 - 60	70 - 100	60 - 90	80 - 150	100 - 180	100 - 300
Feed rate (mm)/rev.					
from - to	from - to	from - to	from - to	from - to	from - to
0.0013 - 0.0015	0.0046 - 0.0116	0.0023 - 0.0063	0.0028 - 0.0074	0.0019 - 0.0182	0.0019 - 0.0031
0.0019 - 0.0022	0.0068 - 0.0178	0.0034 - 0.0129	0.0041 - 0.0126	0.0029 - 0.0368	0.0033 - 0.0053
0.0026 - 0.0028	0.0086 - 0.0236	0.0049 - 0.0188	0.0060 - 0.0176	0.0055 - 0.0589	0.0049 - 0.0088
0.0038 - 0.0040	0.0105 - 0.0300	0.0073 - 0.0242	0.0070 - 0.0234	0.0078 - 0.0859	0.0063 - 0.0154
0.0052 - 0.0056	0.0127 - 0.0362	0.0092 - 0.0311	0.0080 - 0.0293	0.0106 - 0.1178	0.0078 - 0.0214
0.0071 - 0.0077	0.0145 - 0.0424	0.0112 - 0.0377	0.0088 - 0.0377	0.0127 - 0.1466	0.0094 - 0.0273
0.0092 - 0.0100	0.0185 - 0.0495	0.0141 - 0.0440	0.0106 - 0.0450	0.0165 - 0.1717	0.0122 - 0.0324
0.0120 - 0.0126	0.0235 - 0.0603	0.0172 - 0.0563	0.0123 - 0.0565	0.0192 - 0.2167	0.0154 - 0.0414
0.0147 - 0.0165	0.0280 - 0.0728	0.0201 - 0.0676	0.0144 - 0.0674	0.0235 - 0.2624	0.0176 - 0.0498
0.0176 - 0.0209	0.0343 - 0.0859	0.0231 - 0.0795	0.0166 - 0.0804	0.0282 - 0.3140	0.0198 - 0.0578
0.0207 - 0.0240	0.0394 - 0.0983	0.0261 - 0.0917	0.0188 - 0.0942	0.0333 - 0.3550	0.0220 - 0.0659
0.0240 - 0.0270	0.0500 - 0.1100	0.0310 - 0.1030	0.0230 - 0.1040	0.0420 - 0.3960	0.0260 - 0.0750
0.0280 - 0.0330	0.0600 - 0.1330	0.0370 - 0.1260	0.0270 - 0.1250	0.0520 - 0.4780	0.0310 - 0.0930
0.0340 - 0.0400	0.0700 - 0.1560	0.0420 - 0.1460	0.0320 - 0.1460	0.0630 - 0.5600	0.0350 - 0.1110
0.0380 - 0.0460	0.0790 - 0.1780	0.0470 - 0.1650	0.0370 - 0.1660	0.0710 - 0.6310	0.0400 - 0.1310
0.0430 - 0.0530	0.0870 - 0.2010	0.0520 - 0.1820	0.0420 - 0.1870	0.0780 - 0.6920	0.0440 - 0.1510
0.0510 - 0.0600	0.1060 - 0.2240	0.0630 - 0.1990	0.0510 - 0.2070	0.0940 - 0.7540	0.0530 - 0.1670
0.0630 - 0.0730	0.1230 - 0.2700	0.0730 - 0.2340	0.0600 - 0.2460	0.1100 - 0.8710	0.0620 - 0.2010
0.0720 - 0.0860	0.1410 - 0.3160	0.0840 - 0.2690	0.0700 - 0.2810	0.1260 - 0.9890	0.0700 - 0.2340
0.0860 - 0.1000	0.1690 - 0.3620	0.0990 - 0.3010	0.0850 - 0.3150	0.1490 - 1.0990	0.0840 - 0.2680

highly suitable

unsuitable

suitable at limited degree

suitable at limited degree

Cutting speed and feed rate are dependent on tool length, coolant type and material being drilled, as well as the stability of the drilling machine and workpiece clamping. All figures specified are guide values.

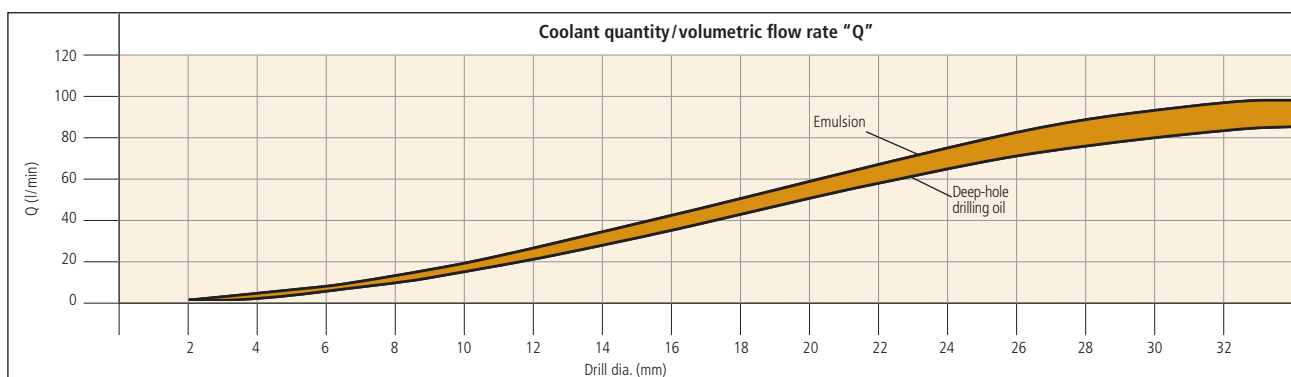

Reliable chip removal is only assured if sufficient coolant is supplied to the tool. The diagrams show our recommendation for coolant pressure and quantity by drill diameter and drilling depth.

Technical Information

Application notes for botek deep hole drilling tools (single flute gundrills)

1. Before using the drills make sure the machine has the necessary equipment to do proper deep hole drilling. The machine should have suitable safety guarding for protection from cutting chips and coolant for operator. Check with machine builder!
2. Improper use or handling of deep hole drilling tools can cause serious injuries, e.g. skin cuts from the cutting edge.
3. Deep hole drilling tools are not self centering and can be unbalanced. Therefore the drills must be guided **during the start of the drilling cycle** by means of a sufficiently long drill bush or pilot hole (see detail "Z" on below illustration). For information on the guide hole (pilot hole) see page 5.

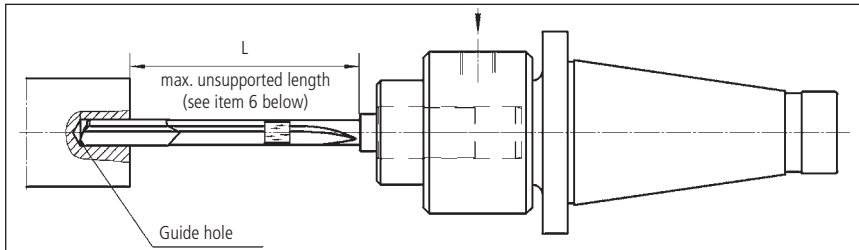

4. The gundrill is fed into drill bush or pilot hole **while non rotating** or rotated slowly at < 50 RPM. Then the coolant and the machine spindle should get started.
 5. **After reaching the drilling depth** switch off the coolant and retract with the spindle stopped or slowly rotated at < 50 RPM.
 6. **Tool support: unsupported drill length** should **never** exceed the dimensions as shown on table (6a). If the unsupported drill length is exceeded the drill might cause injury.
- 6a. **Guide values for tool support of botek deep hole drilling tools (gundrills):**

<p>Maximum unsupported drill length (L) between the steady rests or in a guide hole</p>		<p>Single flute gundrills:</p>
		<p>Type 110 with brazed drill head</p> <p>Type 113/Type 113-HP solid carbide gundrill</p>
<p>Example 1: Type 110: drill diameter D = 2.0 mm, unsupported drill length up to maximum 80 mm = 40 x D Example 2: Type 110: drill diameter D = 2.0 mm x 200 mm OAL, 1st support at 80 mm and 2nd support at 160 mm</p>		

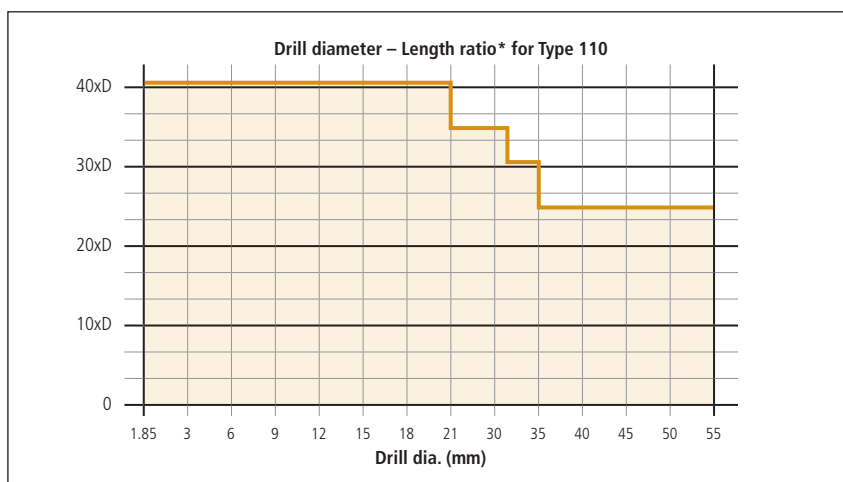

For applications with a pilot hole please refer to the recommendations on page 5 „dimensions for the guide hole“.
 * Length ratio \triangleq max. unsupported length (see point 3).

Application notes for botek deep hole drilling tools (single flute gundrills)

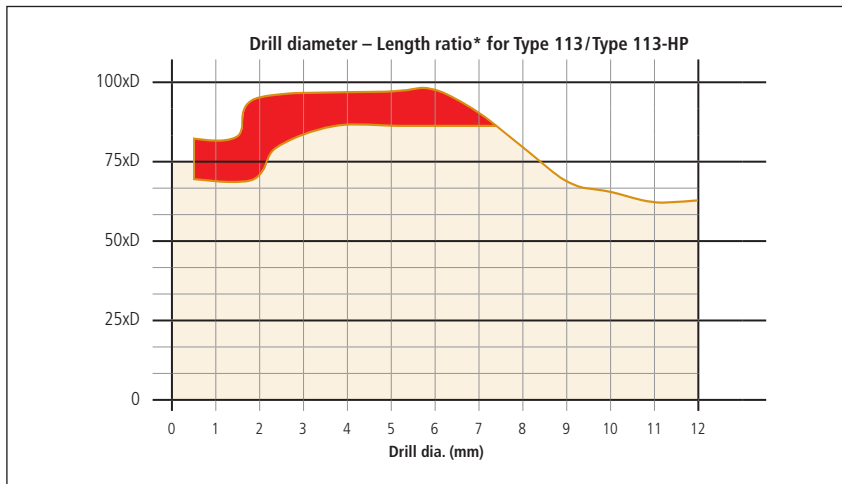

The area marked red indicates a critical zone, where feed rate (max. 25% of value given in catalogue) and especially rotational speed (50%) must be reduced. That means: A tool with a dia. 1.6 mm can only be increased to the value given in the catalogue once the unsupported length is shorter as 70 x Dia. From dia. 7.0 mm onwards the length – diameter ratio is within acceptable limits. For applications with a pilot hole please refer to the recommendations on page 5 „dimensions for the guide hole“.

* Length ratio $\hat{=}$ max. unsupported length (see point 3).

7. Grinding of carbide produces dust (cobalt, etc.) that may be potentially hazardous. Use adequate ventilation and safety glasses during grinding to make sure that the legal limit of pollution is given.
8. **Consequences of not following** our application notes No. 1 - 7

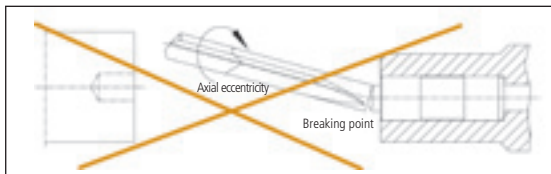

Using botek gundrills other than directed may cause personal injury. Tool breakage and unsupported gundrills can be extremely dangerous.

Please use with caution and care.

Please note that all application notes and values contained herein are intended as guidelines only. We do not accept any liability for damages caused by improper handling of botek deep hole drilling tools, operating errors, unsuitable machinery or misuse while using our tools!

Do you have any further queries? Please call up at P +49 7123 3808-0. We will be pleased to offer you advice.

Consumable accessories

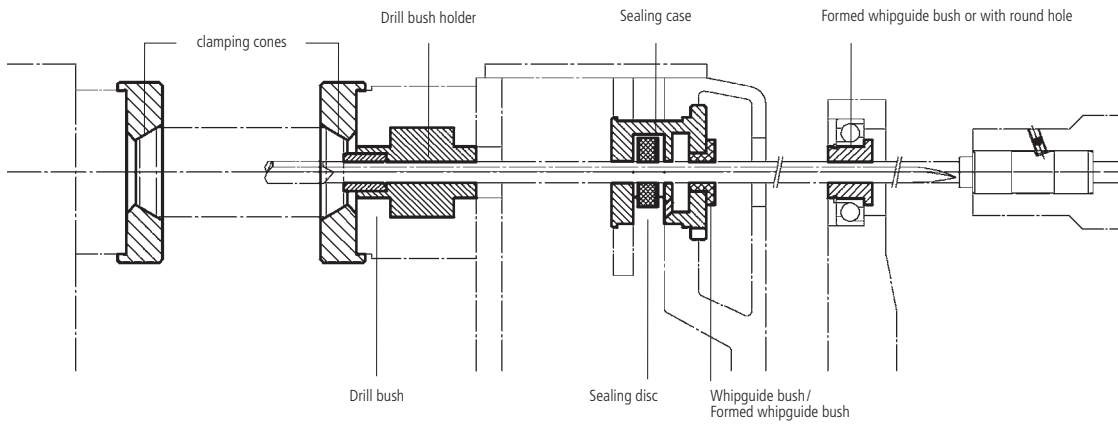

Whipguide bush	Tool dia. (mm)	D	L	l1	d	Drawing no.	botek order no.
	1.850 - 15.399	25	22	12	Please specify tool dia. and outer dia. (D) when ordering	170-05-4-1060	792 000 509
	1.850 - 25.609	30	26	16		170-05-4-1238	792 000 511
	1.850 - 36.699	45	26	14		170-05-4-1341	792 000 512
	1.850 - 25.609	35	26	14		170-05-4-2227	792 000 510
	1.850 - 25.609	30	26	13		170-05-4-2278	792 000 513
	1.850 - 36.699	45	26	16		170-05-4-2279	792 000 514
	1.850 - 11.799	20	22	12		170-05-4-2650	792 000 508
	1.850 - 32.600	40	26	15		170-05-4-3897	792 000 515
Formed whipguide bush	Tool dia. (mm)	D	L	l1	d	Drawing no.	botek order no.
	3.960 - 12.509	20	20	12	Please specify tool dia. and outer dia. (D) when ordering	170-05-4-1809	792 000 516
	4.750 - 22.609	30	26	14		170-05-4-1810	792 000 517
	7.800 - 36.699	45	26	16		170-05-4-1812	792 000 519
	29.610 - 50.000	75	40	20.3		170-05-4-1816	792 000 520
Whipguide bush	Tool dia. (mm)	D	L		d	Drawing no.	botek order no.
	1.850 - 12.399	22.6	15		Please specify tool dia. when ordering	170-06-4-1180	792 000 535
Sealing disc	Tool dia. (mm)	D	L		d	Drawing no.	botek order no.
	1.850 - 5.749	20	3		Please specify tool dia. and outer dia. (D) when ordering	170-07-1572	792 000 500
	3.960 - 5.749	32	3				792 000 501
	5.750 - 20.509	32	4				792 000 501
	5.750 - 25.609	40	4				792 000 502
	23.610 - 49.999	90	4				792 000 503
Special sealing disc	Tool dia. (mm)	D	L		d	Drawing no.	botek order no.
	2.900 - 5.249	20	7		Please specify tool dia. when ordering	170-07-4-3885	792 000 504
	5.250 - 16.399	32	11			170-07-4-3886	792 000 505
	16.400 - 25.999	40	12			170-07-4-3887	792 000 506
	26.000 - 40.999	90	12			170-07-4-2708	792 000 507
Drill bushings					d	Drawing no.	botek order no.
	Cylindrical drill bushings to DIN 179-A in middle version made from hardened tool steel Special drill bushings on request				Please specify tool dia. when ordering	170-04	

Consumable accessories

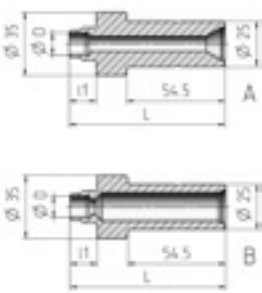
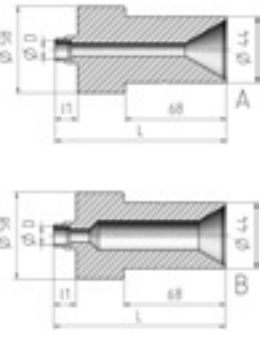
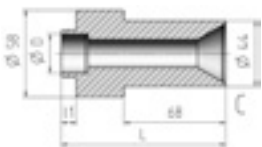
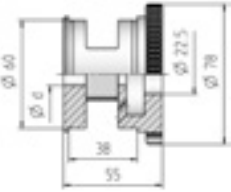
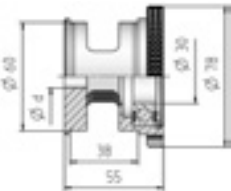
Drill bush holder (small) in versions A and B (depending on drilling range)	Drilling range (mm) from - to	L	l1	Version	d	botek order no. and version
	0.500 - 2.699	88.5	17	A or B	Please specify tool dia. and version when ordering	170-03-3-2538 A, B
	2.700 - 5.099	87.5	16			
	5.100 - 8.099	86.5	15			
	8.100 - 12.099	88.5	14			
	12.100 - 15.099	83.5	12			
	15.100 - 18.099	81.5	10			
Drill bush holder (large) in versions A, B and C (depending on drilling range)	Drilling range (mm) from - to	L	l1	Version	d	botek order no. and version
	1.800 - 2.699	117	17	A or B	Please specify tool dia. and version when ordering	170-03-3-2979 A, B or C
	2.700 - 5.099	116	16			
	5.100 - 8.099	115	15			
	8.100 - 12.099	114	14			
	12.100 - 15.099	112	12			
	15.100 - 18.099	110	10			
	18.100 - 30.099	106	6	C		
	30.100 - 35.099	103	-			
Sealing case	Tool dia. (mm)	d			botek order no.	
	Whipguide bush with round hole for dia. 1.850 - 12.399	Please specify tool dia. when ordering Note: Tools with dia. 1.850-12.399 can be supported with a whipguide bushing. Whipguide bush and sealing disc to be ordered separately			170-01-03-1570	
Sealing case (with bearing)	Tool dia. (mm)	d			botek order no.	
	with whipguide bush for dia. 1.850 - 25.609 formed whipguide bush for dia. 5.750 - 22.609	Please specify tool dia. when ordering Whipguide bush with round hole or formed whipguide bush (max. outer dia. 30 mm) and sealing disc to be ordered separately			170-01-4-1809	

Service

Customer testing in our research and development department:

- tool development specifically tailored to suit your application
- supportive when introducing the latest technology
- solving processing problems

We are looking forward to meet your challenge – please contact us.



We support you in the case of process reliability from deep and precise holes as follow:

Process layout: You pretend us your drilling application and we will develop the whole process from engineering find the perfect tooling solution.

Process optimization: Our team of Application Engineers analyse and improve your process in your facility and calibrate all technical details.

Cost reductions of your manufacturing:

- perform feeds and speeds
- perform prober toollife
- minimized antiliary process time
- minimized process ability, output and quality

is our goal.

The botek trial-department assists you in all phases of the process with:

- capability test
- performing trails
- training events for your technicians

We are looking forward to meet your technical challenge.

After-Sales Service

The case of our customers does not end after the delivery of the tools – **IT BEGINS WITH IT.**

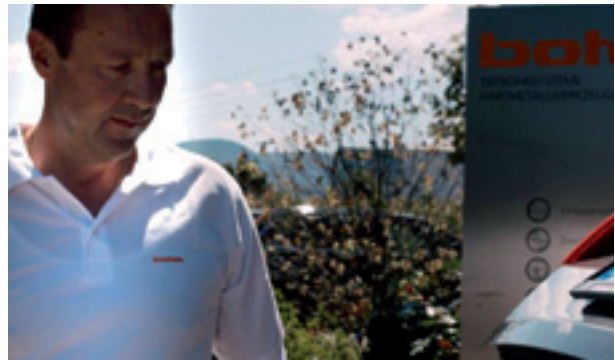

Coating

botek offers prompt and cost effective in house coating service.



Regrinding

botek offers prompt and cost effective in house regrinding service.

Re-tipping

Tools get equipped with a new drill head (requirement is that drill tube and driver can be used).

Express production line

With our botek Express production line tools can be manufactured that are not in our stock program.

The delivery program includes following tools:

- Single flute and two fluted gundrills with brazed drillhead Type 110/Type 120
- Solid carbide gundrills – Type 113
- Single flute gundrills with inserts – Type 01

Please send us your inquiry.



Regrinding

botek grinding fixture



Using **botek grinding fixtures**, single flute gundrills can be reground on any good tool grinding machine. Depending on tool diameter, botek grinding fixtures are available as Model ZS (see illustration left) or Model PS (for solid carbide gundrills).

MS-01/MS-01-T

For grinding **small** batches, we supply the botek MS-01 single station grinding machine (with worktop).



You can easily install the above mentioned botek grinding fixtures on this machine.

MS-12



For highly efficient grinding of **large batches** of tools with the same point geometry, we recommend **botek MS-12 multi-station grinding machine.**

The machine is suitable for **tool diameters from 1.850 to 12.000 mm and tool lengths up to approx. 1.000 mm,** and is available with either 2 spindles (MS-12) or 3 spindles (MS-12/3) (standard version without lamp).

After you have set the fixture, you will obtain consistent and economical regrinding results easily and quickly with botek machines.



For detailed information, refer to brochure 'botek Grinding Machines and Accessories'

Coolant pressure gauging kit/Rotating coolant connector

Coolant pressure gauging-kit for machining centres and deep hole drilling machines

Quite often the set value at the pressure gauge is not reflecting the value that actually reaches the tool. Numerous sources for errors such as leaking valve parts, faulty rotating connectors or snapped hose lines are not visible on first sight. Leading to a decreased coolant pressure, this could influence the drilling result negatively.

The gauging-kit developed by botek measures the real pressure – directly at the spindle/tool (up to a max. of 160 bar).

The following methods are available:

1. Measurement of the machine pump performance:

By means of a tool dummy a tool-independent check can be carried out – a big advantage.

2. Measurement with the tool:

The tool dummy is replaced by the actual drill.
The pressure can be checked directly at the tool.





For machining centres:		
Spindle adaptor for collect chuck ER-32 with cylindrical shaft Ø 16.0 (h5) mm / Ø 20.0 (h5) mm / Ø 25.0 (h5) mm, incl. nut for sealing disc assembly	1 pc.	1*
Collet chucks ER 32 (4/6/8/10/12/16/20 mm)	7 pcs.	2
Sealing discs (4/6/8/10/12/16/20 mm)	7 pcs.	3
Dummies for tool simulation	14 pcs.	4
Open end wrench for adaptor	1 pc.	5
Wrench for nut	1 pc.	6
For deep hole drilling machine:		
Special adaptor for driver 25x100/112 as per VDI 3208 (ZH25-34)*. The adaptor can be modified to suit different drivers, if required.	1 pc.	7*
Smaller lathe and machining centres:		
Dummy adaptor Ø 10.0 mm / Ø 45.0 mm incl. 4 dummies	adaptor and 4 dummies	8*
Allen key, size 8	1 pc.	9
Aluminium case	1 pc.	

* Manometers with "drag-indicator" are available for an additional charge. (This device can be used when no line of sight is possible during the actual measurement)

Rotating coolant connector

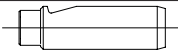
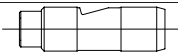

Spindle Adapter	Ø-range tool	Order no. (* ex stock)	Driver	max. RPM (min ⁻¹)	max. pressure (bar)
MK3	up to 25.000	507 000 513	 ZH16-03/ZH16-04	10.000	100
		507 000 547	 ZH16-02/ZH16-33		
		507 000 498	 ZH25-00/ZH25-01		
		507 000 508	 ZH25-22/ZH25-31		

* ex stock

botek[®]

DEEP HOLE DRILLING SYSTEMS
SOLID CARBIDE TOOLS

botekUSA

200 N Garden Avenue
Roselle, IL 60172

Phone (630) 893-5300

E-Mail Info@botekUSA.com

www.botekUSA.com